

Mitteilungen

40. IWASA

Internationales Wasserbau-Symposium
Aachen 2010

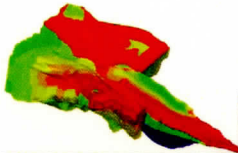

**Innovative Methoden und
Ansätze in Wasserbau und
Wasserwirtschaft**



**SHAKER
VERLAG**

Bibliografische Information der Deutschen Nationalbibliothek

Die Deutsche Nationalbibliothek verzeichnet diese Publikation in der Deutschen Nationalbibliografie; detaillierte bibliografische Daten sind im Internet über <http://dnb.d-nb.de> abrufbar.

Copyright Shaker Verlag 2011

Alle Rechte, auch das des auszugsweisen Nachdruckes, der auszugsweisen oder vollständigen Wiedergabe, der Speicherung in Datenverarbeitungsanlagen und der Übersetzung, vorbehalten.

Printed in Germany.

ISBN 978-3-8322-9984-2
ISSN 1437-8477

Shaker Verlag GmbH • Postfach 101818 • 52018 Aachen
Telefon: 02407 / 95 96 - 0 • Telefax: 02407 / 95 96 - 9
Internet: www.shaker.de • E-Mail: info@shaker.de

Vorwort

Am 7. und 8. Januar 2010 fand das 40. Internationale Wasserbau-Symposium Aachen (IWASA 2010) unter dem Motto „Innovative Methoden und Ansätze in Wasserbau und Wasserwirtschaft“ in der AGIT in Aachen statt.

Der Wasserbauingenieur steht heutzutage im Spannungsfeld unterschiedlicher Nutzungen der Gewässer zunehmend komplexeren, weil interdisziplinären und skalenübergreifenden Fragestellungen gegenüber. Aufgrund der abnehmenden natürlichen Ressourcen, des dramatisch zunehmenden wirtschaftlichen Nutzungsdrucks auf die Gewässer und einer zunehmenden Besiedlungsdichte unter veränderten natürlichen Randbedingungen bei reduzierten finanziellen Mitteln sind nachhaltige Konzepte für die langfristige Nutzung, den Schutz und das Management der Gewässer erforderlich. Dies erfordert vom Wasserbauingenieur die Entwicklung innovativer Methoden und Ansätze, die alle Bereiche des Wasserbaus und der Wasserwirtschaft von der Forschung bis zum Monitoring eines realisierten Projektes betreffen.

Hieraus ergab sich die Veranlassung das IWASA 2010 unter diesem Motto zu organisieren und in die Themenblöcke Experimentieren, Simulieren, Planung, Bauen und Überwachen zu unterteilen.

In den ersten beiden Veranstaltungsblocken zu den Themen „**Experimentieren**“ und „**Simulieren**“ werden neue, innovative und interdisziplinäre Ansätze, Methoden und Modelle des wasserbaulichen Versuchswesens sowie der numerischen Simulation vorgestellt. Am Beispiel ausgewählter Forschungsprojekte wurde hier die aktuelle Entwicklung in der Wissenschaft aufgezeigt.

Im dritten Veranstaltungsblock unter dem Thema „**Planung**“ wurden innovative Projekte im Planungsprozess präsentiert, die aufgrund ihrer Komplexität, der vielfältigen Randbedingungen sowie besonderer Anforderungen eine Herausforderung an den planenden Ingenieur darstellen.

Doch auch die Baupraxis erfordert vom Wasserbauingenieur zunehmend die Bewältigung neuer, komplexer und interdisziplinärer Fragestellungen. Daher wurde der vierte

Veranstaltungsblock dem Thema „**Bauen**“ gewidmet. Am Beispiel ausgewählter Bauprojekte sollten beispielhaft innovative Bauverfahren und -methoden im Wasserbau behandelt werden.

Auch die Unterhaltung und Überwachung bestehender wasserbaulicher Anlagen verlangen die Entwicklung neuer Messverfahren, Methoden und Ansätze vom Wasserbauingenieur und Wasserwirtschaftler, um wasserbauliche Infrastrukturen dauerhaft funktionsfähig zu halten und neuen Randbedingungen anzupassen. Diese Aspekte waren das Thema des fünften Veranstaltungsblocks unter dem Titel „**Überwachen**“.

Abschließend möchte ich allen Vortragenden, Autoren und Teilnehmern des 40. IWASA für ihre Teilnahme, ihr Engagement sowie die zahlreichen Diskussionen danken. Mein Dank gilt auch den Ausstellern und Sponsoren, ohne deren Mitwirken diese Veranstaltung nicht möglich wäre. Der Dank gilt weiterhin den Mitarbeiterinnen und Mitarbeitern des Instituts für Wasserbau und Wasserwirtschaft für die Organisation des IWASAs in der AGIT in Aachen.

Aachen, im Dezember 2010

Holger Schüttrumpf

Inhaltsverzeichnis

Verzeichnis der Aussteller und Sponsoren VII

Die Grenzen des Wachstums sind überschritten! – zur Notwendigkeit einer globalen ökosozialen Marktwirtschaft –

U. Möller 1

Experimentieren

Destructive tests on inner slopes of dikes by the Wave Overtopping Simulator

J. van der Meer 8

Hydrotoxische Untersuchungen schadstoffbehafteter Sedimente im Kreisgerinne

C. Cofalla, M. Brinkmann, S. Roger, S. Hudjetz, U. Kammann, X. Zhang, S. Wiseman,
J. Giesy, M. Hecker, J. Wölz, H. Hollert und H. Schüttrumpf 28

Wasserbauliche Modellversuche zur Sanierung des Hochwasserrückhaltebeckens Goldberger Teich

J. Jensen und S. Felder 48

Simulieren

Simulation als Teil des Risikomanagements – Erfahrungen aus dem Unstrut Projekt

A. Schumann 59

Vom Taktischen Drehpunkt zum Schiffsführungssimulator – Modellverfahren zur Fahrrinnenbemessung

C. Heinzlmann, B. Söhngen und T. Dettmann 74

Die Erstellung einzugsgebietsweiter HW-Schutzkonzepte als komplexe Ingenieur- aufgabe

O. Buchholz 86

Planen

Innovations in Navigation Lock Design

P. Rigo 110

Gewässerökologie, Regenwasserbehandlung, Hochwasserschutz – Nachweis von Synergien durch komplexe Planungswerkzeuge

D. Schitthelm 133

Bauen

Neubau der Zwillings Schleuse Münster: Technische Bearbeitung – Ausführung der Bauleistungen

K. Simoneit und R. Wienkamp 143

Sanierung alter Dichtungssysteme in Trinkwasser- und Triebwasserkanälen

G. Heerten 162

Überwachen

Innovative Instrumente für sichere Binnenwasserstraßen









G. Boettcher 176

Der Einfluss vertikaler Landbewegungen auf langwellige Wasserstandsbeobachtungen

A. Sudau und R. Weiß 191

Verzeichnis der Aussteller und Sponsoren

Wir danken folgenden Firmen und Institutionen für ihre freundliche Unterstützung:

aqua_plan Ingenieurgesellschaft für Problemlösungen in Hydrologie und Umweltschutz mbH Goethestraße 5 52064 Aachen	
BASF Polyurethane Elastogranstraße 60 49448 Lemförde	 The Chemical Company
BERDING BETON GmbH Industriestraße 6 49439 Steinfeld	
Björnsen Beratende Ingenieure (BCE) GmbH Maria Trost 3 56070 Koblenz	 BJÖRNSEN BERATENDE INGENIEURE
CENO Membrane Technology GmbH Postfach 1861 48257 Greven	 creating membrane solutions
Dahlem Beratende Ingenieure GmbH & Co. Wasserwirtschaft KG Bonsiepen 7 45136 Essen	
Deltares P.O. Box 177 2600 MH Delft Niederlande	 Enabling Delta Life
DHI-WASY GmbH Max-Planck-Straße 6 28857 Syke	
Franz Fischer Ingenieurbüro GmbH Holzdamm 8 50374 Erftstadt-Liblar	 INGENIEURBÜRO GmbH

Innovations in Navigation Lock Design

Philippe Rigo

Abstract

This paper introduces the Report 106 on "Innovations in Navigation Lock Design" published by PIANC in August 2009. Main objectives and issues are highlighted in this paper. This report was achieved by the INCOM Working Group 29 of PIANC from 2006 to 2009.

Acknowledgements

The author thanks MM. BÖDEFELD Jörg, BOS Jan, CLARKSON John, DALY Fabrice, FERNANDEZ Jose Luis, HIJDRA Arjan, HIVER Jean-Michel, HOLM Olli, HUNTER Peter, MILLER Dale, PECHTOLD Erwin, PICHON Nicolas, POLIGOT-PITSCH Stephanie, SARGHIUTA Radu, TARPEY Michael, THORENZ Carsten, WONG Juan, WU Peng, as co-authors of the PIANC 106 Report (2009).

The present paper will be published at MMX-PIANC'2010, May 2010, Liverpool, UK.

1 Introduction

Locks are key structures for the development of the navigation in canals and in natural rivers where weirs regulate water levels to enable navigation. They may also be strategic infrastructure for port development. In lower elevation regions, such as New Orleans and the Netherlands, locks are structures in dikes and also have an important task in flood defence.

In 1986, PIANC produced a comprehensive report of 445 pages on Locks. For about twenty years this report has been considered as a world reference guideline, but it needed updating to include new design techniques and concepts. PIANC decided in 2006 to launch a new Working Group (WG) to update the report, and the present report is the result.

The core of this report has three major parts. The first part presents an exhaustive list of design goals associated with locks. This section is particularly important for decision makers who have to launch a new project. The second part reviews the design principles that must be considered by designers. This section is methodology oriented. The third part is technically oriented. All main technical aspects (hydraulics, structures, foundations, including computational aspects, etc.) are reviewed, focussing on changes and

innovations occurring since 1986. Perspectives and trends for the future are also listed. When appropriate, recommendations are listed.

Other major changes since 1986 concern maintenance and operational aspects, and more specifically how to consider these criteria as goals for the conceptual and design stages of a lock. Renovation and rehabilitation of existing locks are also an increasingly important topic for the future.

The PIANC n°106 report also includes on a DVD more than 56 reviews of existing locks (or lock projects under development) which describe the projects and their innovative aspects. Some purely innovative and untested concepts are also mentioned as references although with no guarantee of validity.

1.1 Report 2009's DVD

To assist continuity and to avoid duplication of existing PIANC material the former 1986 PIANC Report on Locks is included on the DVD attached to the 2009 report (Directory A3). In addition, the former Table of Contents is given in Annex I of the new report. These documents should be used as support to this report and as a baseline of standard practice.

Due to publishing constraints the number of pages of the InCom-WG29's hardcopy report was limited. Therefore additional information has been saved on a companion DVD (attached to this PIANC hardcopy report). Care should always be taken to use the current versions of standards and other publications that might supersede the versions on the DVD.

This DVD includes the following directories:

- A1: The Project Reviews of 56 lock projects
- A2: PIANC'2009 Lock Report, n°106
- A3: PIANC'1986 Lock Report – in French and English
- A4: PIANC Dictionary on Locks & Waterways
- A5: LIST of LOCKS (Worldwide list)
- Additional information to various sections of this report (Directories B) such as:
 - o B4.6.1: Salt Water Intrusion
 - o B4.6.5: 3D Video Modelling of Construction Process
 - o B5.2: Hydraulic (Manoeuvring, Fendering, ...)
 - o B5.5: Gates and Valves
 - o B5.7: Lock Equipment

- B5.8.5: Lubricants and Bio Oils
- Various technical guidelines (Directories C) :
 - C1- Estoril'2006 - PIANC Congress Papers
 - C2- Beijing'2008 - AGA-2008 Papers
 - C3- Navigation Lock - Ecluse de Navigation (by N.M Dehousse, 1985) in French
 - C4- Corps of Engineering, USA - Reports on Innovation
 - C5- Chinese Codes
 - C6- French Guidelines - Lubaqua (CETMEF)
 - C7- Fish Passage In Lock
 - C8- Corrosion Protection
 - C9- Planning of Lock Maintenance (example)
 - C10- European Code For Inland Waterways (CEVNI)
 - C11- Ship Impact
 - C12- Seismic Impact of Lock Gates
 - C13- ISPS Code 2003 - IMO (Safety and Security of Ship and Port)
 - C14- Panama Third Lock Lane
 - C15- Seine Nord Europe Canal (France)
 - C16- Three Gorges Locks, China
 - C17- Specifications for Lock Design (Lanaye Lock, Belgium)
- Sponsor Company's References (Directory D):
 - Bureau GREISCH (BE)
 - IMDC (BE)
 - TECHNUM (BE)
 - Planning and Design Institute for Water Transportation (PDI, China)
 - Guanxi Xijiang Navigation Construction Co. Ltd. (China)
 - Compagnie Nationale du Rhône (CNR, France)
 - Grontmij / BGS Ingenieurgesellschaft mbH (D)
 - Delta Marine Consultants (NL)

- Rijkswaterstaat (NL)
- ISPH (Romania)
- IDOM (Spain)
- Ben C. Gerwick, Inc. (USA)
- InCom WG29 meeting pictures, (Directory E)

2 Project Reviews

An important feature of Report 106 is the availability of many detailed project reviews in which the practical use of innovations are presented (Figure 1 to Figure 7).



Fig. 1: Example of Project reviews – Sevilla (Spain)

Representative samples of each lock type are summarized in Chapter 2 of the report. Case studies (56 in total) of each of these locks are included on the attached WG 106-CD-Rom (Directory A1).

The case studies include a complete description of the locks, foundations, gate types, hydraulic systems, construction methods and, where available, cost. Photographs and selected engineering drawings are also presented for many of the locks (Figure 2-3).

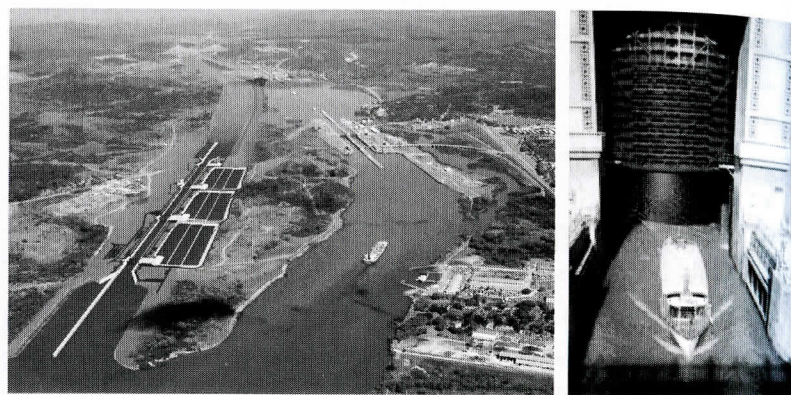

Fig. 2: Examples of Project reviews – Panama (left), Rhone in France (right)

Each project was reviewed and the innovative features applied to that project are described.

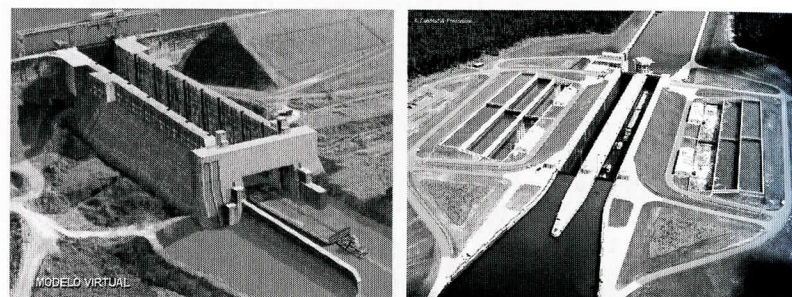

Fig. 3: Examples of Project reviews – Turucui Brazil (left), Hohenwarthe – Germany (right; Source: Luftbild & Pressefoto)

These innovative features were ranked into five general classifications. Those innovations and their classifications are shown in Table 2.1 in the report (see Table 1).

The selected project reviews do not exhaustively cover all aspects, but are representative for the innovations currently in use or currently in the phase of research or design.

Table 1: Layout of Table 2.1 in the report

		Hydraulics		O & M		
		Filling and Emptying Systems	Water Management (Water Saving Basins)	Energy Management	Life Cycle Cost	Maintenance
Project Reviews						
1	1-01 Kallø Sea Lock					PT
2	1-03 Self-Propelled Floating Lock					
3	1-04 High-Rise Navigation Lock	AC				
4	1-05 Van Cauwelaert Lock					
5	2-01 Tucuruí Lock		PT			

Members of WG 106 selected projects for which they or their associates have experience in the lock design or construction (Figure 4). Many of the projects fall under multiple categories in their areas of innovation.

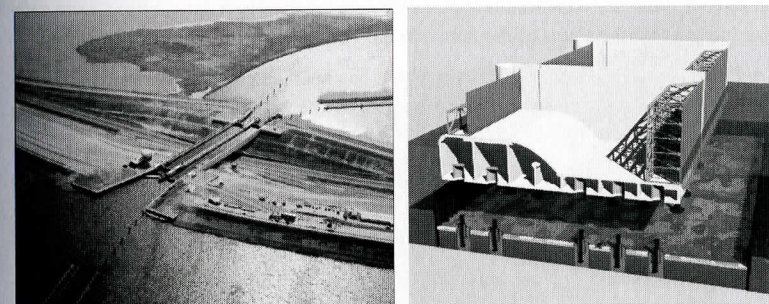

Fig. 4: Project reviews – Naviduct-NL (left), Float in Segment – Braddock-USA (right)

In order to show what these areas are in a systematic way, five major categories and appropriate subcategories were created as follows:

- Hydraulics
- Operation and Maintenance (Figure 5)
- Environmental
- Design / Construction
- Miscellaneous

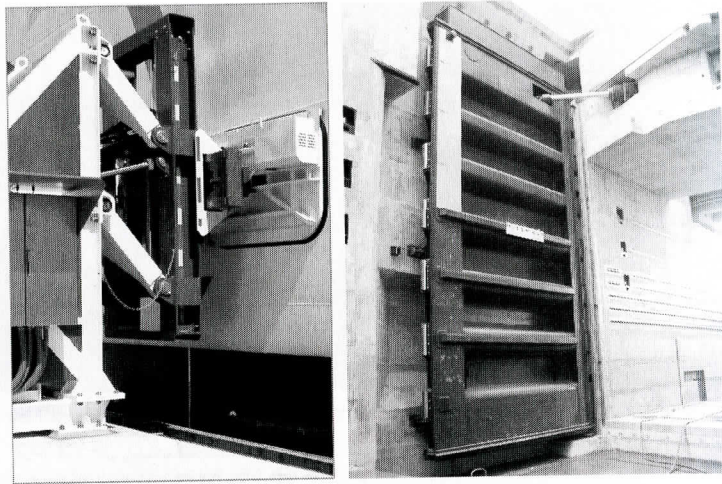

Fig. 5: Examples of Project reviews – Mooring System (left), folded plate miter gate and capsulated hydraulic actuator (right)

Each project summary enhances few innovative concepts. These innovations were categorized to indicate the status of the innovations. The following definitions were used.

- A **PROVEN INNOVATION** is one which has been researched, designed and constructed. It is been in service for a number of years and has possibly been constructed at multiple locations.
- An **UNPROVEN CONCEPT** is one that has been recently constructed and as such the viability of the concept has not been validated by time and sufficient use for potential shortcomings or needed modifications to become apparent.
- A **NEW CONCEPT** is a concept that has been validated by a client and is in design. Construction is currently scheduled or will be as funding becomes available.
- An **ADVANCED CONCEPT** is one that is currently in research. A prototype may have been built to establish proof of the concept but it has not yet been accepted for construction or for regular operations.

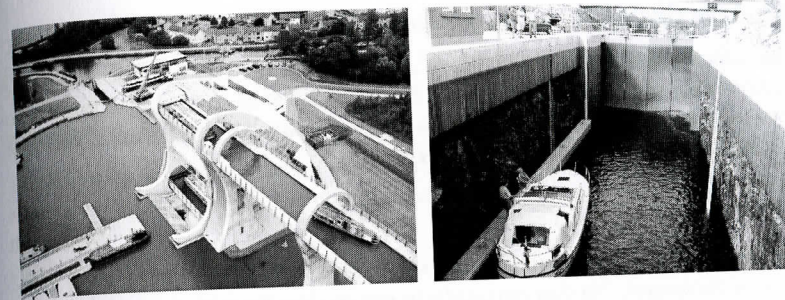

Fig. 6: Project reviews: Falkirk Wheel – UK (left), Floating Pontoon and lock in the rock – Finland (right)

Because each review may represent multiple innovations the project reviews have not been categorized by innovation. They are organized alphabetically by country.

Short summaries of each project review are included in Section 2.3 of the report. Detailed reviews and contact information for each project are included on the WG 106-CD-ROM.

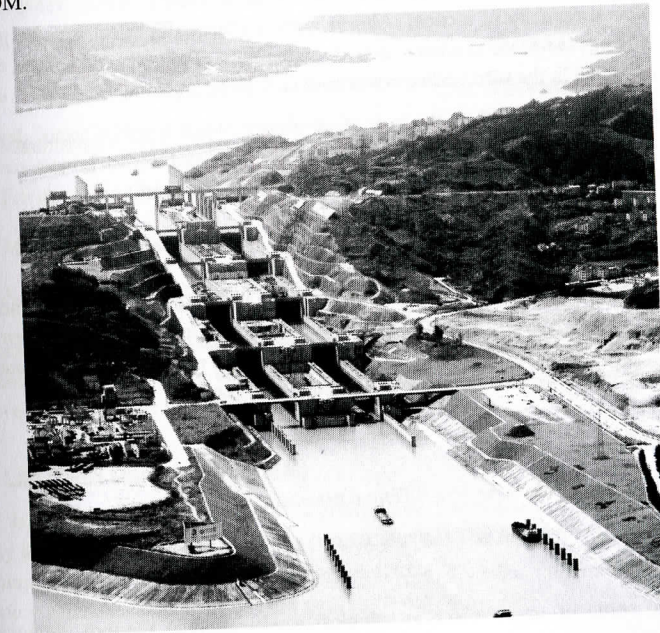

Fig. 7: The Three Gorges Project (China)

3 Live Cycle Cost and Lock Design Objectives

The comprehensive 1986 PIANC report on Locks (PIANC, 1986) provides a mass of detailed data and recommendations for the planning and design of locks. But it also focuses on new areas of design objectives that have become more important since 1986, like the live cycle cost of navigation locks.

3.1 General Project Objectives

The objectives and priorities of planning and design a lock vary depending on the viewpoint of the assessor, but they can usually be grouped into financial, economic and environmental categories. Safety is a theme running through all these categories. They all require detailed evaluation to allow logical decisions when selecting optimum solutions or deciding whether to proceed with a proposed project.

3.2 Economic and Financial Objectives

There can be more than one reason for constructing a new lock or waterway. It might be to reduce maintenance costs, or to allow larger ships to reduce overall transport costs and to increase capacity of a canal. Alternatively a waterway project may be justified because it brings increased economic activity in the form of tourism and leisure, both on the waterway and in the surrounding waterfront land areas.

Financial objectives depend on the type of developer. While a public sector developer might not need to raise revenue directly from users, a private sector project such as a marina may require revenues from users to fund the project directly.

3.3 Environmental Objectives

This issue has become of overriding importance since the 1986 PIANC report, and often governs the decision whether a project should go ahead. Local and regional environmental impacts of all aspects of construction and operation now have to be evaluated, to assess whether the project complies with statutory requirements.

3.4 Priorities

The design approach can have four different priorities:

- Design for lowest initial (construction) cost;
- Design for minimum maintenance;
- Lowest whole life cost, which is a logical combination of the two previous approaches;
- Best performance (fastest operation, least down-time).

The selection of priorities depends on the objectives of the owner/developer of a project.

3.5 Main Design Objectives

The following are the main design objectives for lock design, and many of these were relatively low priority at the time of the previous report (PIANC, 1986, numbered as in that report):

- 3.2 Reliability and proven technology
- 3.3 Reliable lock operations
- 3.4 Life Cycle Management
- 3.5 Lock navigation cycle
- 3.6 Water motions inducing ship displacement and mooring forces
- 3.7 Water resource problems:
 - Water shortage
 - Saltwater intrusion
- 3.8 Minimizing energy use
- 3.9 Environmental impacts
- 3.10 Minimizing impacts of construction
- 3.11 Security and Safety

Of course the first point "*Proven Technology*" does not match with the use of innovation, and a major reason for adopting innovative concepts and materials is to achieve improved performance, reliable design or reduced costs.

3.6 Life Cycle Management (LCM)

LCM is a management approach to infrastructure construction to achieve optimum quality and minimum Whole Life Cost (WLC). For locks, a reduced WLC should imply optimum levels of reliability (which must be determined specifically for each project), and more efficient maintenance. This does not mean less inspection and survey or less maintenance.

3.7 Safety

Safety has become another increasingly important aspect of design for locks. As well as highlighting many areas of design that can lead to increased safety (e.g. mooring, lighting, signs, channel design and gate protection), the report (PIANC, 2009) also provides a classification of different types of water edge structure and gives guidelines for suitable safety treatment for each type.

4 Innovations in Traditional Filling and Emptying Systems

Hydraulic systems for filling and emptying locks can be divided into two main types. One is the filling and emptying "through the heads"; and the other is the "through longitudinal culverts" system. Within these filling and emptying systems, the "In Chamber Longitudinal Culvert System" (ILCS) and "Pressure Chamber under the Floor System" are new types developed after 1986.

In recent years some locks in Germany have been equipped with a filling system which uses a pressure chamber beneath the floor. This type of filling system has proven to be very efficient especially in combination with water saving basins.

In general the ILCS system could be used for intermediate lift locks. Under specific conditions, such as in rock, a large saving in lock wall construction costs could be realized if the lock filling and emptying culverts were located inside the lock chamber rather than within the lock walls. The WG29 report reviews these systems, previous implementations, guidelines for the selection of a system, utilization in combination with other methods such as water saving basins, and optimization of the systems.

Table 2: Complexity categories of hydraulic systems

Complexity	Hydraulic systems	Lock cost
1. Simple systems	<ul style="list-style-type: none"> - Through the head system - Wall culvert side port system - In-chamber longitudinal culvert system (ILCS) 	Low
2. More complex systems	<ul style="list-style-type: none"> - Wall culvert bottom lateral system - Longitudinal culverts under the lock floor - Wall culvert bottom longitudinal system - Longitudinal culverts under the lock floor 	Higher
3. Very complex systems	<ul style="list-style-type: none"> - Dynamically balanced lock filling system - Pressure chamber under the floor 	Highest

The objectives to choose a proper filling and emptying system are to get a proper filling/emptying time (not as short as possible) and to get a lower cost with the proper filling time. In general the simpler the filling and emptying system is, the lower the lock cost as shown in Table 2.

Energy dissipation is a major problem in filling and emptying systems. For a specific filling and emptying system, you can raise the hydraulic efficiency of the system (or shorten the filling time) by optimizing the energy dissipation measures.

Following are some examples to improve the efficiency of filling and emptying systems (studied in China).

4.1 Partial Distributed System

Through the head system is a very simple and low cost system. But it can be only used for locks with very low lift height. Based on the principle that distributed (longitudinal culvert) filling and emptying system could improve the operation efficiency of locks, a partial distributed system could be used to raise the efficiency and reduce the cost. The short culverts of the system were extended into chamber walls with bottom lateral branch culverts (Figure 8).

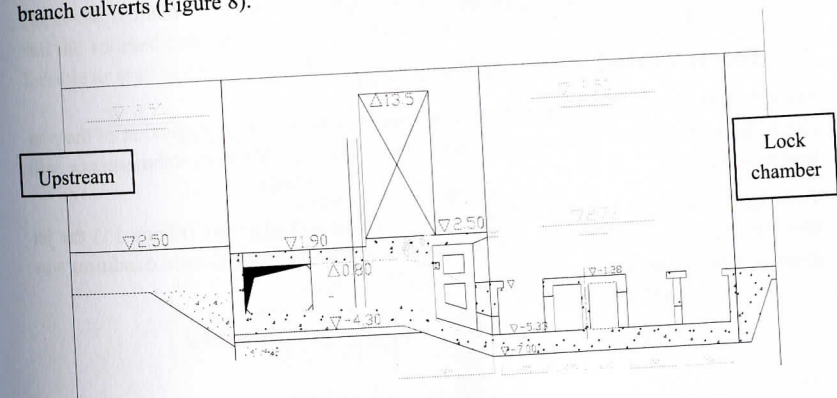

Fig. 8: Partial distributed filling system

4.2 Double Ditches Energy Dissipation System

To avoid dangerous currents at the outlets of filling and emptying system, measures should be taken for energy dissipation. Double ditches are effective system for energy dissipation. Figure 9 shows the double ditches used in bottom lateral system and Figure 10 used in In-chamber Longitudinal Culvert System (ILCS). Compared with one ditch system the filling time was shortened.

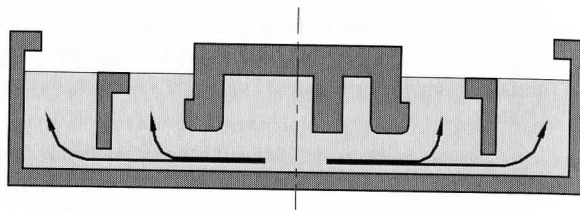

Fig. 9: Double ditches used in bottom lateral system

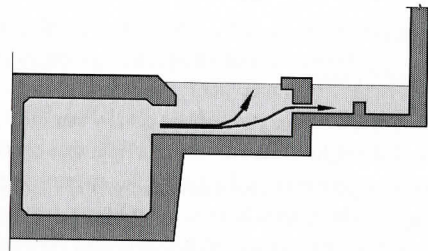

Fig. 10: Double ditches used in ILCS system

4.3 Energy Dissipation for Side Port System

For side port system enough submergence is required to prevent direct action of the port jets against the bottom of the vessel. But in many cases a little more submergence will lead to much cost.

Tests have shown that if port deflectors were arranged in chamber (Figure 11) the jet into the chamber was spread by the deflectors evenly and the hydraulic condition was improved. So the minimum submergence could be reduced.

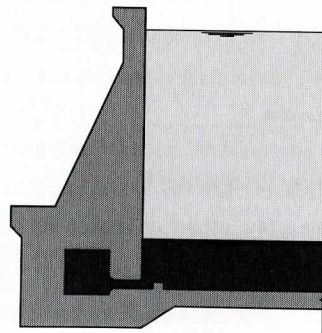

Fig. 11: Side Port System with Port Deflectors

5 Mooring Forces and Ship Behaviour in Navigation Locks

The hydraulic design of a lock filling/emptying system aims at (among other issues) minimization of the filling/emptying time, constrained by the so-called hawser force criterion (De Mulder, 2009). The latter criterion is meant to guarantee a certain degree of safety and comfort to a moored vessel during lockage.

The hawser force criterion attempts to quantify the necessary limitation of 'turbulence' (in the wide sense) generated by the lock filling/emptying, in order to limit the displacement of the vessel and the associated forces in the vessel-positioning system (e.g. mooring lines). Notice that the water flow, the lock (chamber and filling/emptying system), the vessel and its positioning system mutually interact, (see Figure 12).

The appreciation of safety and comfort during a lockage contains both objective (e.g. forces on the vessel, forces in the mooring lines, slope of the water surface, slope of the vessel, displacement of the vessel) and subjective elements (e.g. feeling of the captain, pilot, lockmaster).

The hawser force criterion sets an upper bound (i.e. a threshold) to an objective element (i.e. definition of the criterion). To assess whether a given filling/emptying system meets the defined criterion, a verification tool should be available. In order to assess that the adopted definition and its associated verification tool lead to both safe and comfortable as well as economic lockage's, validation efforts should be carried out.

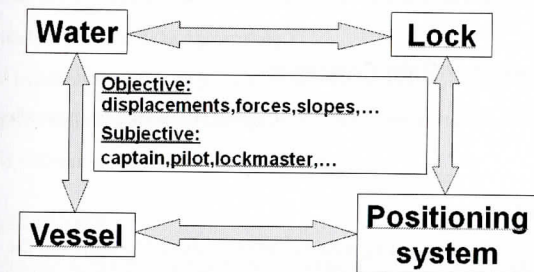

Fig. 12: Constituting elements of a hawser force criterion

6 Construction Methods

The in-the-wet method has recently been applied to the construction of locks and weirs (Figure 4 – right). This innovative method demonstrates several advantages over the conventional construction method, because the prefabrication can be performed in a well-controlled environment, the quality of the construction can be better ensured with this method than with cast-in-place concrete construction. This technique can also provide greater flexibility to the construction process to adapt to varying needs of the site

and the community, such as accommodation of off-season work and easy access of personnel and materials. As a result it can substantially reduce the construction time, helps to reduce adverse environmental impacts and construction risks. In general, this method reduces impact to existing navigation, and can provide considerable cost savings. The WG29 report presents these methods, their respective advantages and disadvantages in comparison with conventional methods, and case studies (Yao and Clarkson, 2009).

In-the-wet construction techniques were first used in the offshore oil industry before evolving into the immersed tunnel and bridge building industry and are a recent development in the construction of locks and dams. This innovative method prefabricates precast concrete or steel modules on land and places them in rivers as the in-situ form into which underwater concrete and mass concrete are then placed directly. The tremie and mass concrete is designed to work in composite structural action with the prefabricated modules. Therefore, a lock or a dam may be constructed without use of a cofferdam.

Selection of a proper erection method for transporting and placing prefabricated modules is an important design decision. The erection method can be generally categorized into the float-in method and the lift-in method. Each method has its special implications on project cost, construction schedules, river traffic, and level of construction risks. In general, a thorough evaluation of the erection method is preferably made in the early design phase, because it affects the structural concept and layout.

7 New Innovative Gate Concepts

This section introduces some new innovative concepts related to gates identified by the INCOM WG29.

a) Reverse Mitre Gate

Recently innovative gate operating systems were designed to combine the link between the gate and the operating cylinder plus a retaining strut to resist the effects of a reverse head imposed by flood conditions. Such system is, in principle, suitable for limited water heads and rehabilitation works.

Nevertheless the progress performed in hydraulic cylinder reverse water heads of 2 and 3 m can be reached (for instance in the IJmuiden locks in the Netherlands). In these cases the cylinders work in compression (reversed head) or in tensile (standard head) – see Figure 13.



Fig. 13: Reverse Mitre Gates (IJmuiden-NL)

b) Folded plate gates

It is now possible to use complex geometric folded plate for lock gate structures (Figure 5). Therefore the advantages are:

- Some redundancy in the bearing capacity
- Simplified maintenance and inspection
- Well designed to avoid fatigue damage
- Favourable corrosion protection characteristics

c) Suspended Mitre gates

There is an innovative solution to the problem of gate hinge wear, so-called 'suspension gate', for mitre or single-leaf gate system (Figure 14). The gate leaves are suspended to a rope, chain or other torque-flexible member – anchored in the leaf rotation axis and hooked to a small tower or console. Both the top and the bottom hinge carry only horizontal reactions in this way, which significantly decreases the wear and helps solving some fatigue related problems (Daniel et al., 2004).

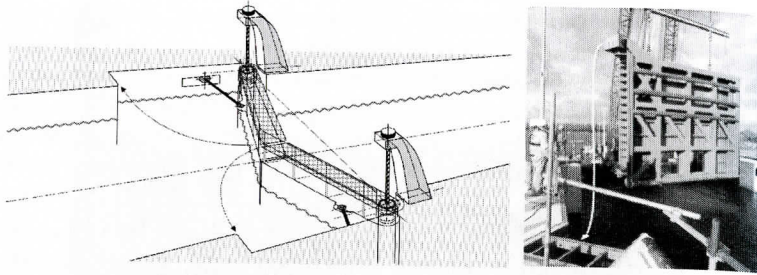

Fig. 14: Suspended Mitre Gate (left); Mitre gates supported only at their top hinges (right)

d) Rotary segment gates with horizontal axis

Rotary segment gates (Figure 15) can be used as an upper lock gate for a large water head if a separate filling system exists. When filling the lock through the gate, a lift height of 8 m is the maximum lift which is currently planned in Germany.

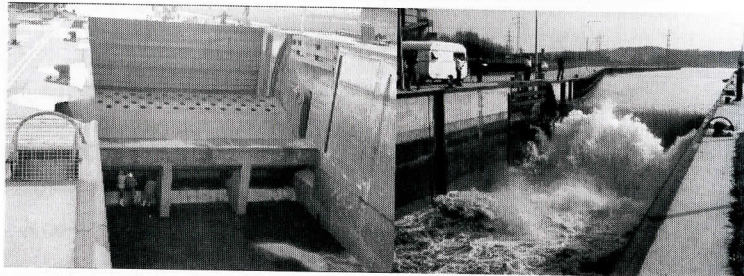

Fig. 15: Upper gate at lock Lisdorf (D) during inspection and during a test for flood discharge

e) Composite lock gates

CETMEF (France) has studied a vertical lift arch gate made out of composite materials. Similarly the "Spieringsluis" in the Netherlands was designed with a high strength synthetic composite material to reduce the higher maintenance costs of wooden or steel gates. The average preventative maintenance duration with wood or steel gates is 15 to 25 years.

Main advantages of composite arch gates are:

- No corrosion;
- Good resistance to aging in damp environment;
- Finishing paint useless, thereby seriously reducing maintenance costs;
- Lightness, easing transportation and fitting of the gate;

- Lightness reducing the purchasing and maintenance costs of the machinery;
- Gate positioning on the river side of the lock heads, easing maintenance and reducing the risk of collision of the gate and/or machinery.

f) Rolling gates with integrated filling/emptying system

In Germany, an innovative gate system (Figure 16) combines the advantages of a lifting gate, where the gate body also forms the closure for filling and emptying the lock chamber, with those of a sliding gate.

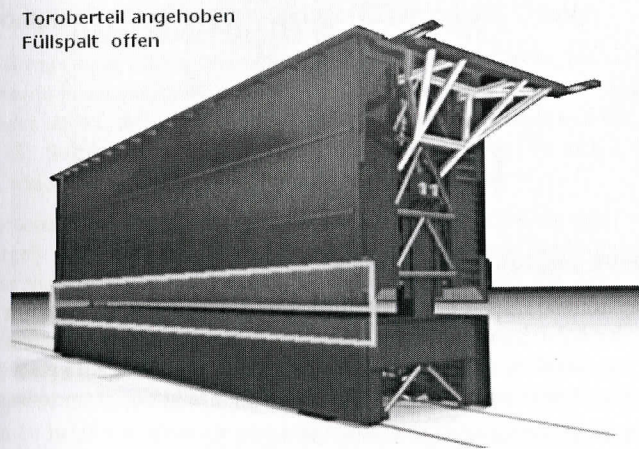

Fig. 16: Kaiser lifting and sliding lock gate

g) Gate tightness, linings and seals

In the Netherlands, Germany, Panama, etc. UHMPE (ultra-high molecular weight polyethylene) is nowadays considered a reliable technology and a very durable material to be used for sliding gate and lock filling and emptying valves.

It is a durable material a) long-service and b) environmentally favourable. It is chemically very stable and its mechanical properties are little sensitive to time, weather etc.

It is also recyclable (products: regenerate UHMPE down to low density PE e.g. for garden furniture) and at the very end it still has a high energy value when burned.

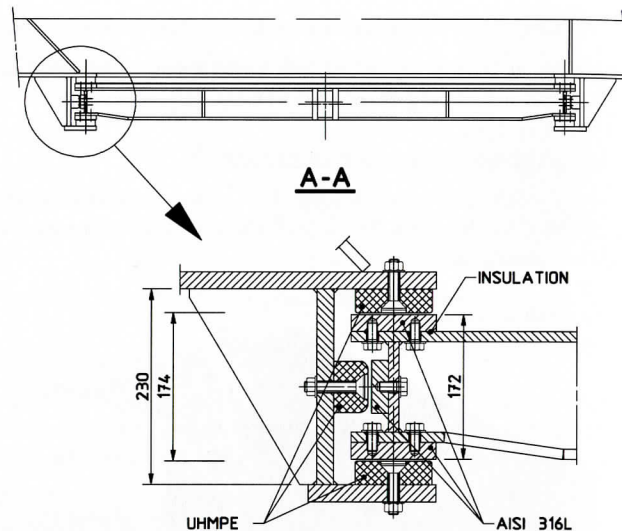

Fig. 17: UHMWPE sliding Gate sluice (Naviduct, NL)

The sliding lift gate (Figure 17) is based on a high mechanical performance sliding material with a low friction coefficient. The material provides both guiding and sealing functions. It is placed on both sides of double-sealed gates and embedded parts depending on the mechanical design adopted. UHMWPE has the following characteristics:

- low friction coefficient (significantly less than 0.2);
- low wear index, which would mean the installation would not require any significant maintenance (wear < 4 mm in 35 years – working life);
- maximum stress = $2 \text{ N/mm}^2 < 6 \text{ N/mm}^2$.

h) Corrosion prevention and corrosion protection

In the last decade, the costs associated with the maintenance of infrastructure (bridges, locks, etc.) have increased dramatically due to the development of more stringent environmental regulations.

Durability and economic maintainability are both directly proportional to corrosion preventive measures taken.

Corrosion prevention of metal, which should be built into the design, must not be confused with corrosion protection, which is regarded as a secondary item to be applied to the structures at the building stage.

The PIANC Report 106 (2009) includes recommendations about corrosion and makes a clear distinction between Corrosion Prevention and Corrosion Protection.

8 Lock Structures and Foundations

In third part (Section 5) of the report, all main technical aspects including new structural concepts, technical aspects and foundations issues are reviewed, focussing on changes and innovations occurring since 1986.

9 Computational Fluid Dynamics (CFD) in Lock Design

A main change since 1986 concerns the arrival of the CFD (Thorenz, 2009). The recent developments in computational methods and the tremendous rise in available computing power have shifted the regions of applicability of numerical models in the last years (Figure 18). Still it must be stated that the filling and emptying of a lock is a complex process, which is not easily replicated in computational models.

The development of computers and numerical models has shifted the range of applicability largely in the last years. Many aspects of fluid flow in locks can be described with computer models. But it must be stated that the most accurate and complete way to predict the behavior of a lock is still a physical model. On the other hand, numerical models can be very helpful for many aspects of lock design. If a new design is based on an older design for which data is available, it can be sufficient to use numerical models to extrapolate this know-how to the new design. In conjunction with physical models, they can be helpful to eliminate unnecessary variants or to model aspects of the fluid flow which are difficult to see or measure in physical models.

Nowadays, Computational Fluid Dynamics (CFD) software is available “from the shelf”. Additionally, computing resources have increased substantially, so that many people start to do CFD simulations. If the person who is doing the simulations is not very well trained and/or of good will to produce quality results, there is a significant danger that only nice pictures will be rendered. For external parties, only looking at the resulting pictures, it is impossible to judge the quality of the results. Especially commercial packages have a tendency to produce results under any circumstances, even if for example the grid resolution is not sufficient for the problem. This is triggered by the tendency that only models of higher dimensionality are “accepted”, so that three dimensional models are being used, even if the available computing resources are not sufficient for quality results. As a result “Colored fluid dynamics” pictures are produced, which have nothing in common with real CFD.

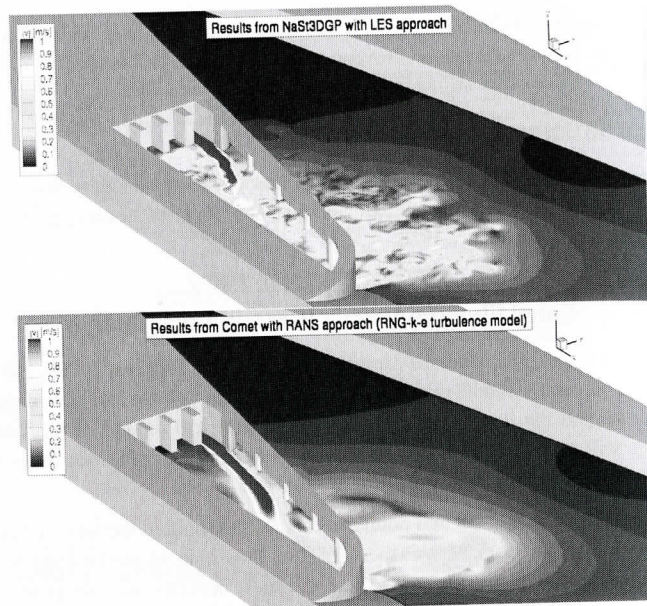

Fig. 18: Detail of computed flow field in the lower approach area of a lock, computed with LES and RANS turbulence models (Thorenz, 2009)

10 Numerical Simulations and Experimental Models: How to Choose?

Since Leonardo da Vinci the experiment has attained a leading and continuously growing role in fluid mechanics research.

It is a prime merit of some scientists at the beginning of 20th century that they developed experimental methods for the solution of hydraulic engineering problems and they succeeded in convincing the profession of the usefulness and validity of this approach. Hydraulic physical modelling developed rapidly into engineering tool of a general recognition for the solution of hydraulic engineering problems.

NUMERICAL MODELLING

During the second part of the 20th century, there is fundamental research concerning the development of some mathematical tools to describe the flow evolution. In parallel, the progress in numerical and algorithmic increases considerably.

Then more numerical models have been applied in some areas of technical hydromechanics with great success. The greater flexibility of numerical models is often compensated by the more convincing intuitive power of the physical model. The market shares of the numerical models have increased in the last century against the physical models.

COMPARISON BETWEEN APPROACHES, LIMITATIONS

Scale model studies have proven a cost-effective means of investigating performance of a proposed structure, provided requirements for hydraulic similitude are met. Idealistically, this requires matching the ratio of appropriate pairs of forces in both scaled model and prototype that play significant roles in the physical being examined.

The effort in constructing a hydraulic physical model is comparable to the effort of working out a solution scheme for the numerical model. Both methods must make use of certain simplifications and approximations and have to be adapted to the real situation in nature – in the one case by adapting the empirical coefficients, in the other case by changing the model roughness.

In numerical models, the decisive limitation is the fact that the majority of flows processes are complex and no closed system of equations can be formulated (incomplete set of equations, turbulence hypothesis...). Another practical limitation is given by the resolution of the model, which is determined by the choice of the grid size for the solution scheme.

For the credibility of a model, it is important to know on the one hand, which experiences are already available with similar types of models, and on the other hand to know the extent of possible feedback between nature and model.

Thus, the results of both physical and numerical models should be carefully examined. For physical models, the model set-up is not very error-prone, but the measuring and interpretation process can lead to errors. In numerical models, most errors are introduced in the conception and set-up phase of the model.

11 Conclusions

PIANC decided in 2006 to launch a new Working Group to update the 1986 report on locks. The new report (n°106) focuses on new design techniques and concepts that were not reported in the former report. It covers all the aspects of the design of a lock. Innovations and changes since 1986 are the main target of the present report.

So if you are convinced, enjoy reading PIANC Report 106.

12 References

- PIANC (1986), Final Report of the International Commission for the Study of Locks, PIANC, Brussels.
- PIANC (2009), Report No.106, Innovations in Navigation Lock Design, PIANC, Brussels
- Daniel R., Vrijburcht A. (2004), Design of Lock Gate, PIANC Bulletin n°117
- De Mulder T. (2009), Mooring forces and ship behaviour in navigation locks, Paper 7 of PIANC Workshop, 15-16 Oct 2009, Brussels.
- Hiver J-M (2009), Numerical Simulations And Experimental Models: How To Choose?, Paper 11 of PIANC Workshop, 15-16 Oct 2009, Brussels.
- Hunter P. (2009), Navigation Locks: Developments In Design Objectives and Methods, Paper 3 of PIANC Workshop, 15-16 Oct 2009, Brussels.
- Pechtold E. (2009), Project Reviews, Paper 3 of PIANC Workshop, 15-16 Oct 2009, Brussels.
- Rigo P.; Gernay T. (2009), Lock Gates – Part A: Innovative Concepts – Part B: Ship Impact, Paper 9 of PIANC Workshop, 15-16 Oct 2009, Brussels.
- Thorenz C. (2009), Computational Fluid Dynamics in lock design - State of the art Paper 10 of PIANC Workshop, 15-16 Oct 2009, Brussels.
- Webb J, Wu Peng (2009), Innovations in Lock Filling and Emptying Systems, Paper 5 of PIANC Workshop, 15-16 Oct 2009, Brussels.
- Yao S.X.; Clarkson J. (2009), In the Wet Construction, Paper 8 of PIANC Workshop, 15-16 Oct 2009, Brussels.

Author

Prof. Philippe Rigo
ANAST – University of Belgium
ph.rigo@ulg.ac.be