

6th European Drying Conference

Convective drying : experimental campaign and numerical modelling

J. Hubert ¹ – E. Plougonven ² – A. Leonard ² – F. Collin ¹

¹ Université de Liège – Dept. ArGenCo

² Université de Liège – Dept. Chemical Engineering

Thesis director : Frédéric Collin

Monday 19th of June

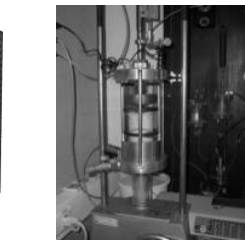
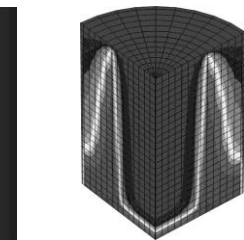
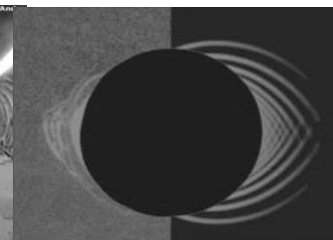
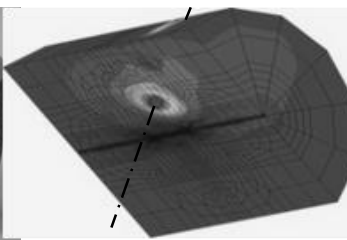
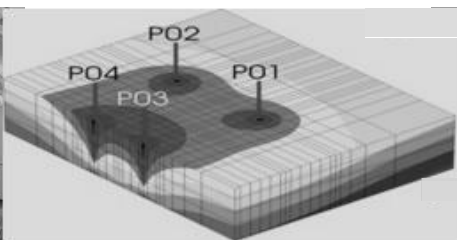

SUMMARY OF THE PRESENTATION

- Scope of the study
- Experimental campaign
- Experimental results
- Model
- Numerical results
- Conclusion

NUCLEAR WASTE DISPOSAL

- High activity long life radioactive wastes need to be isolated for a long period of time ⇒ **Deep geological storage**
 - Stable and low permeability rock formation required
 - ⇒ in Belgium the studied formation is Boom Clay

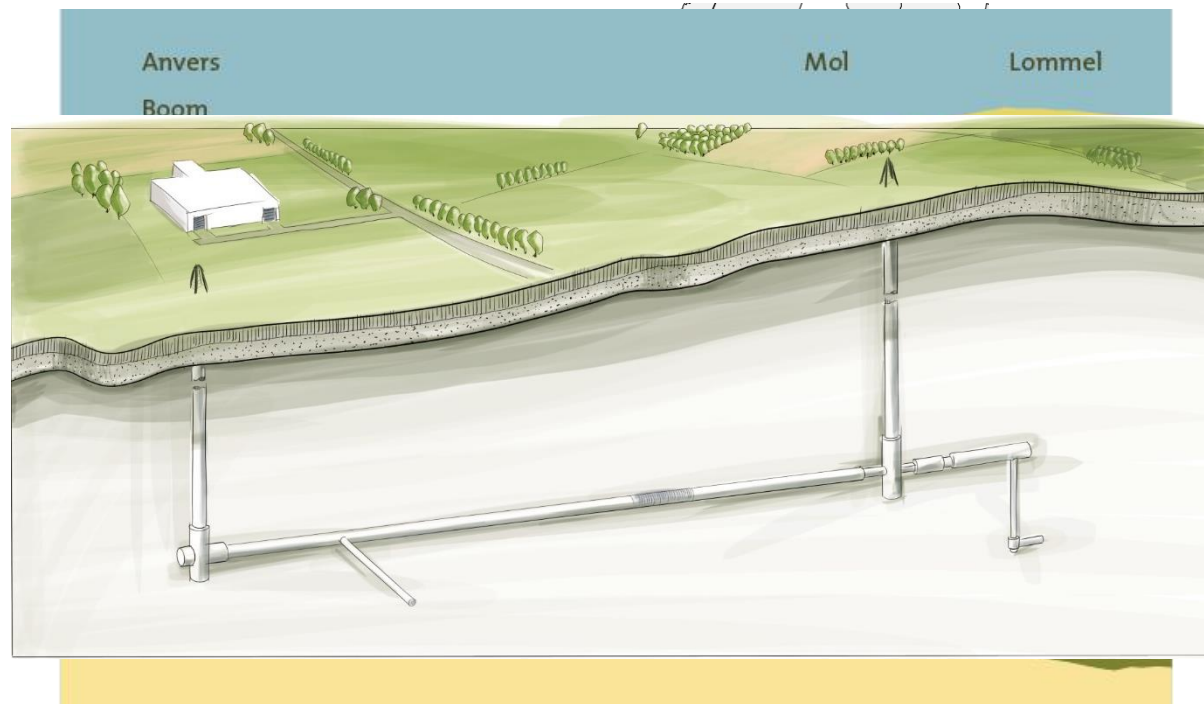

ESV EURIDICE GIE

DEEP GEOLOGICAL STORAGE

- Burial shaft and multi barrier principle:

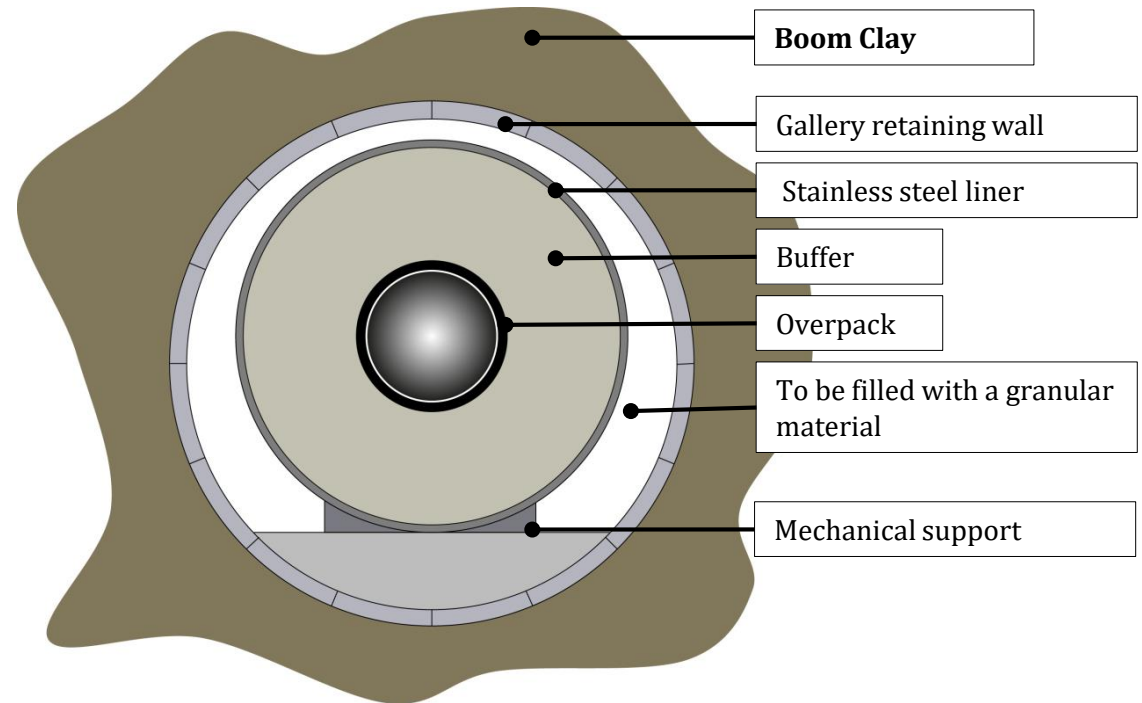
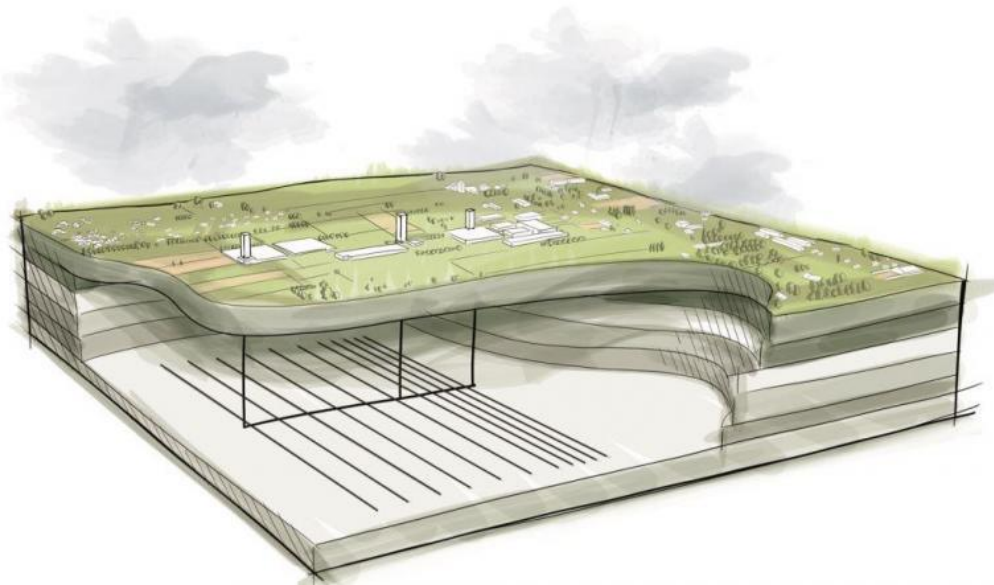

Craye et al., 2009

SUMMARY OF THE PRESENTATION

- Scope of the study
- **Material and method**
- Experimental results
- Model
- Numerical results
- Conclusion

EXPERIMENTAL CAMPAIGN

- Samples preparation

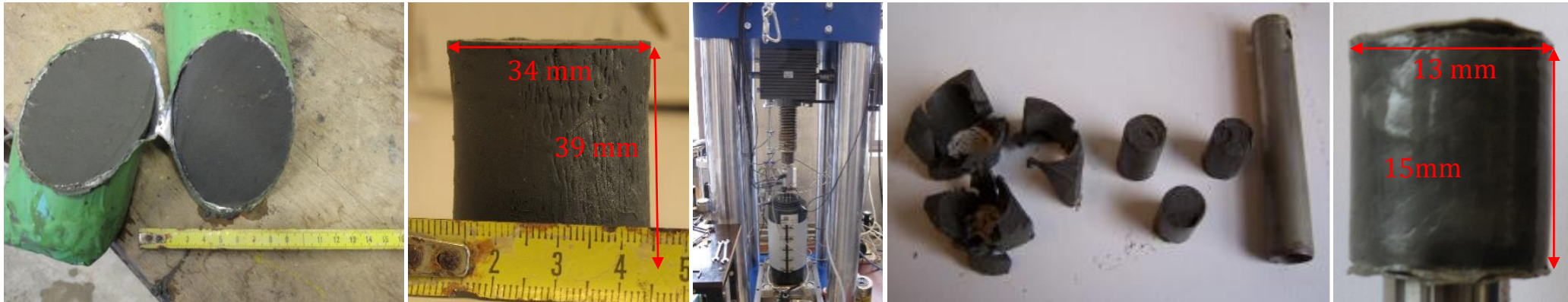

Initial core

Extracted samples

Saturation

Optimization

Finished samples

EXPERIMENTAL CAMPAIGN

- Convective drying tests

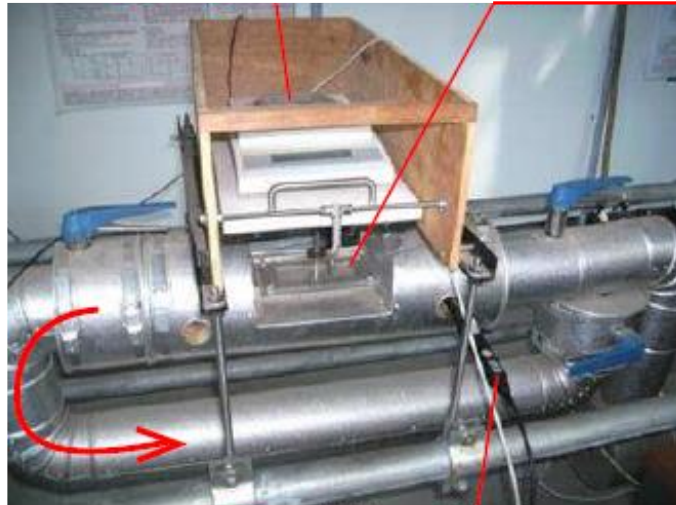

Drying conditions

Temperature	25°C
Humidity	3,5 %
Air flow	0,8 m/s

EXPERIMENTAL CAMPAIGN

- Data acquisition

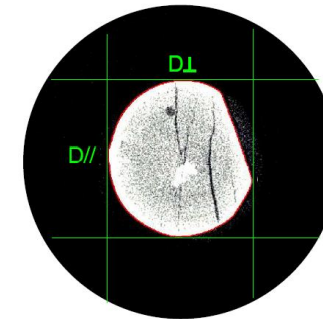
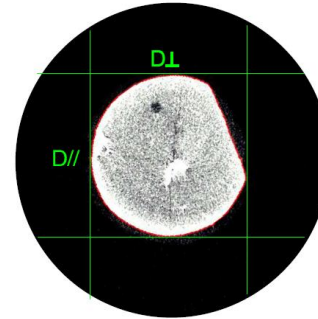

Identification of the bedding direction

Dimensions at saturated state

Dimensions until dry state

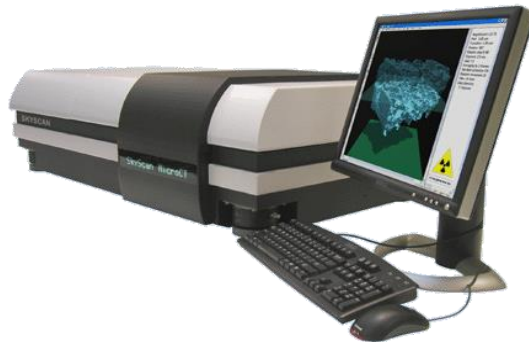

Skyscan 1172

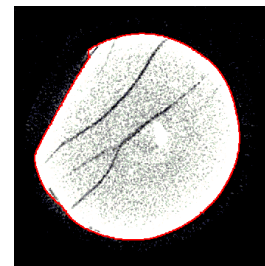

Hole filling and binarization

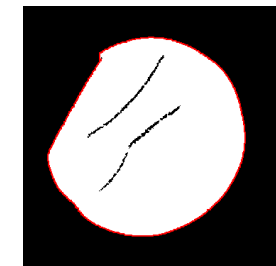

SUMMARY OF THE PRESENTATION

- Scope of the study
- Material and method
- **Experimental results**
- Model
- Numerical results
- Conclusion

DRYING KINETICS

■ Theory of porous media convective drying

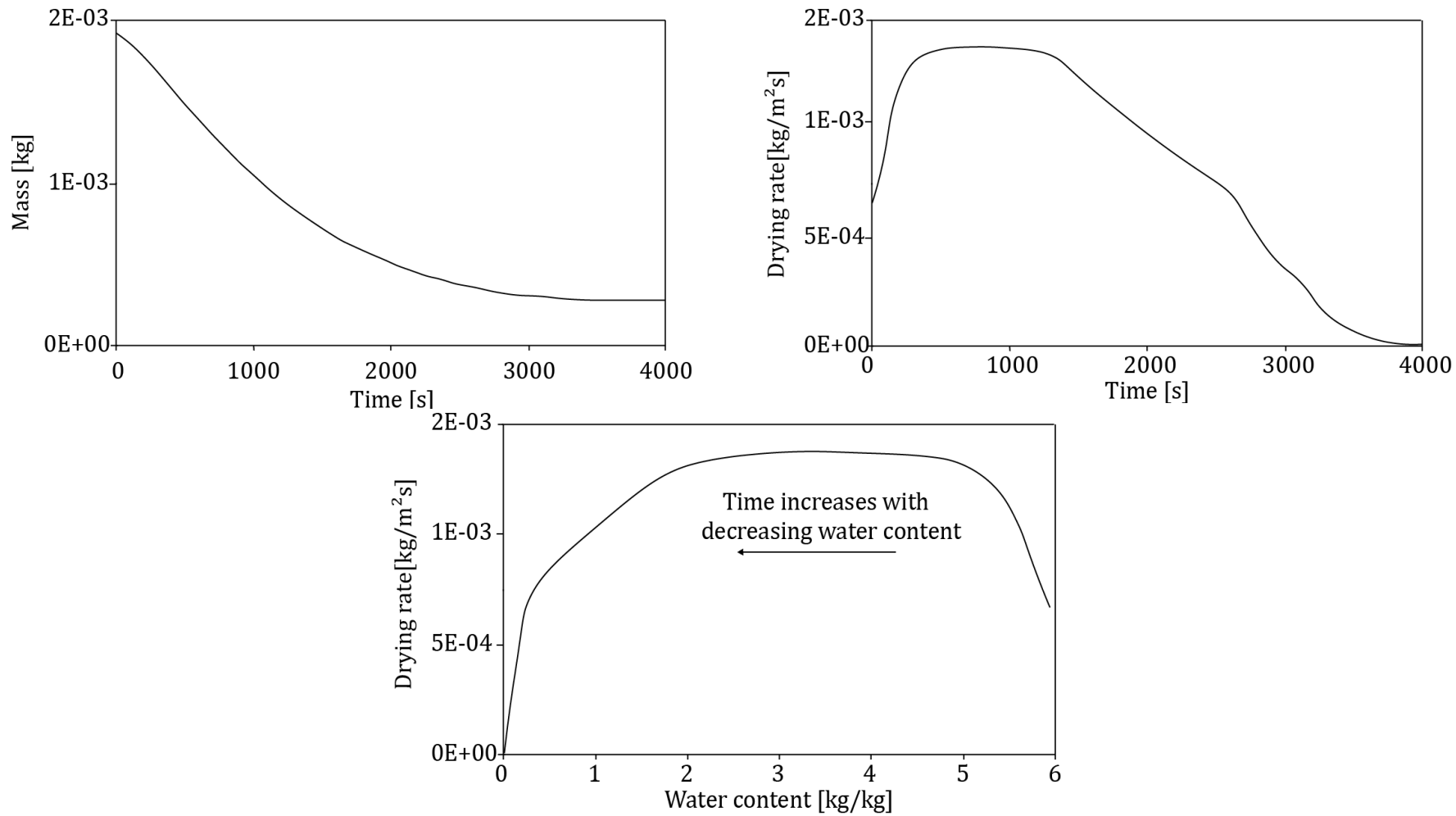

DRYING KINETICS

- Theory of porous media convective drying

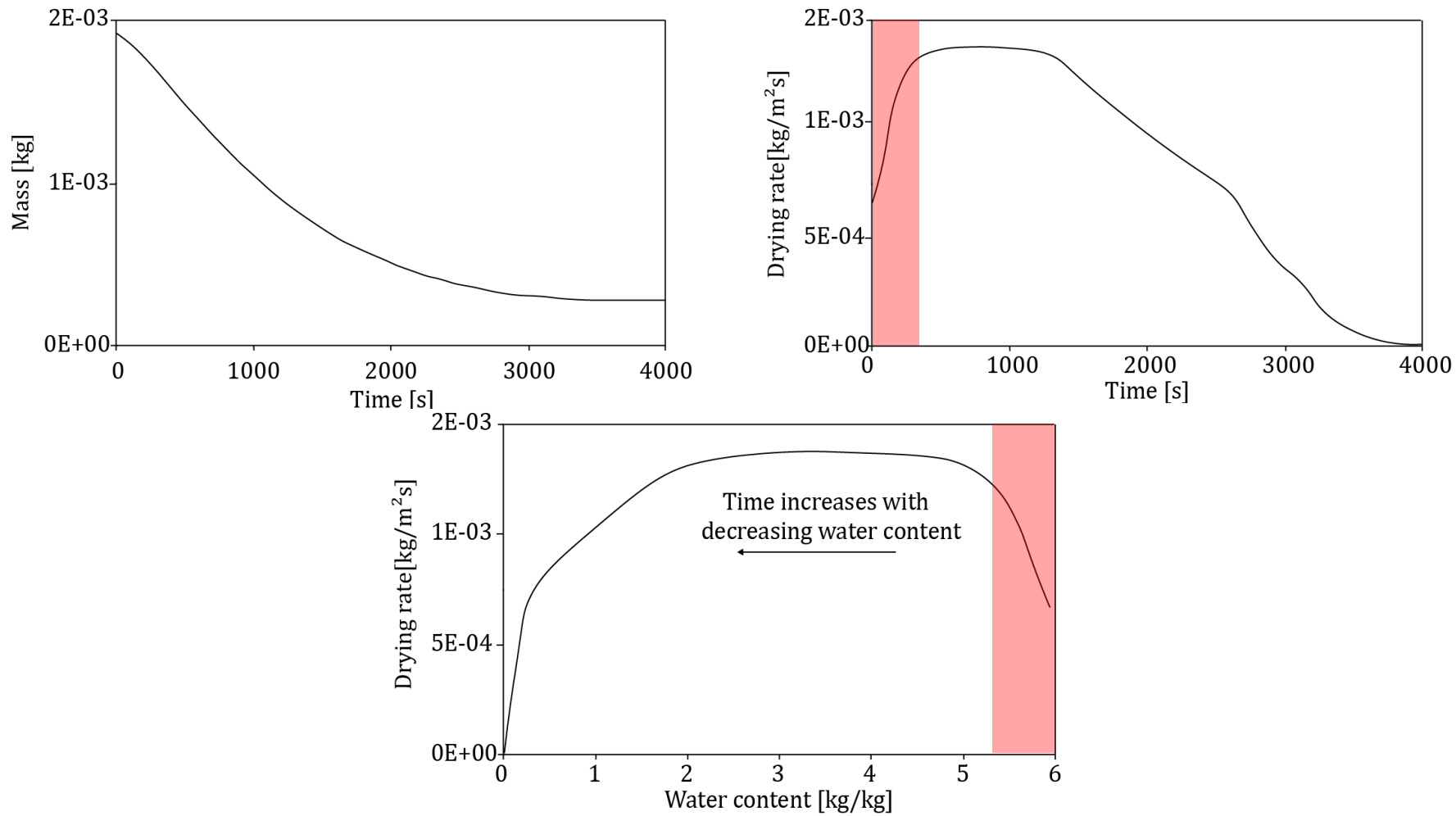

DRYING KINETICS

■ Theory of porous media convective drying

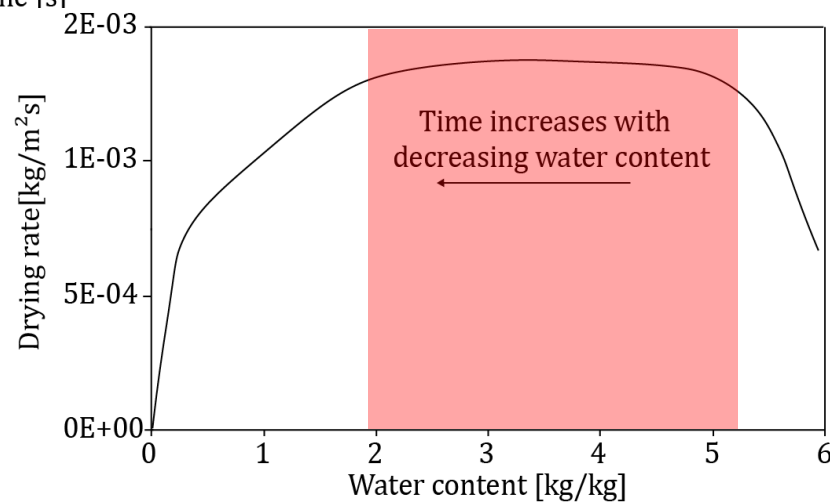
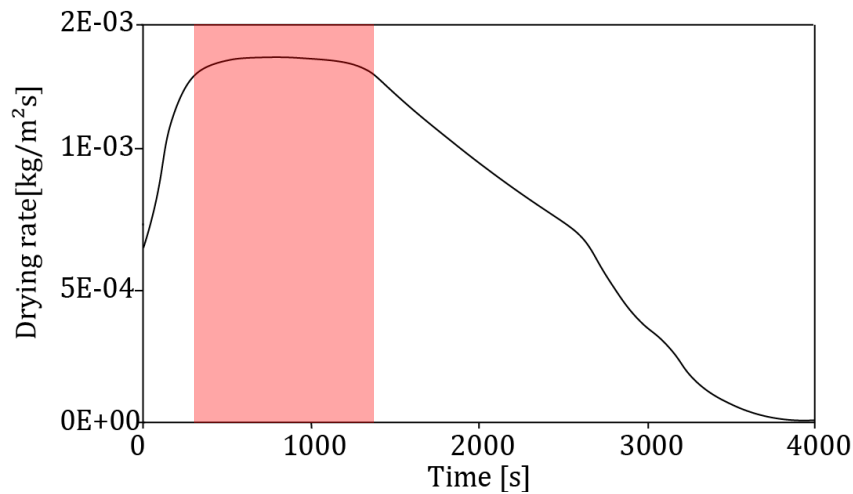
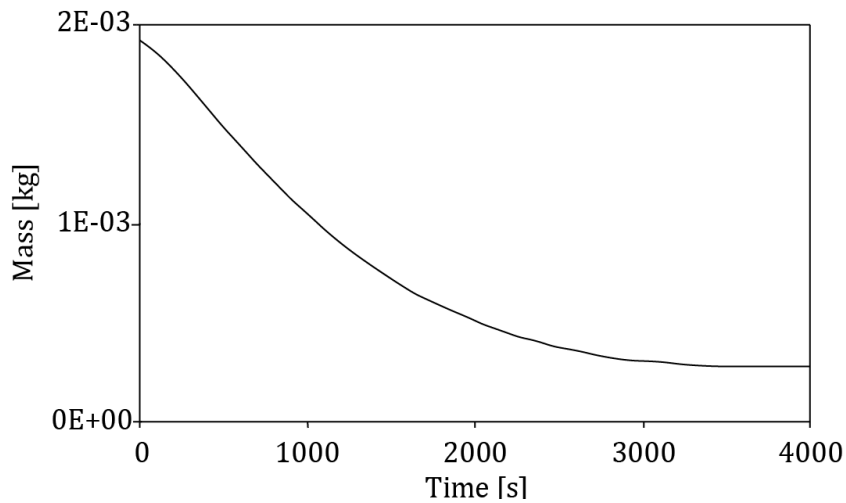

Continuous
Film zone

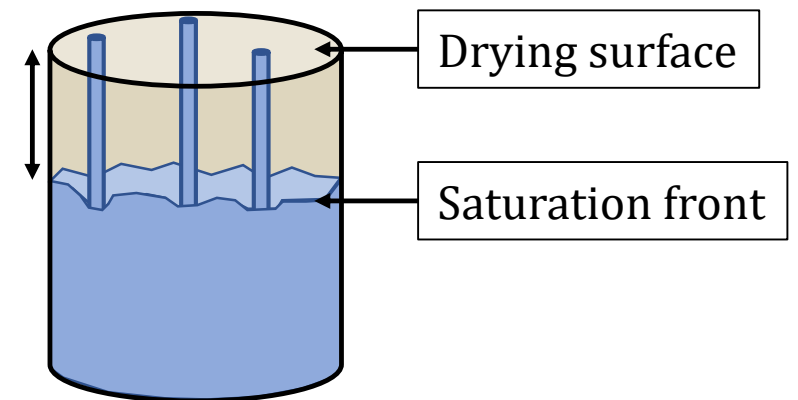

DRYING KINETICS

■ Theory of porous media convective drying

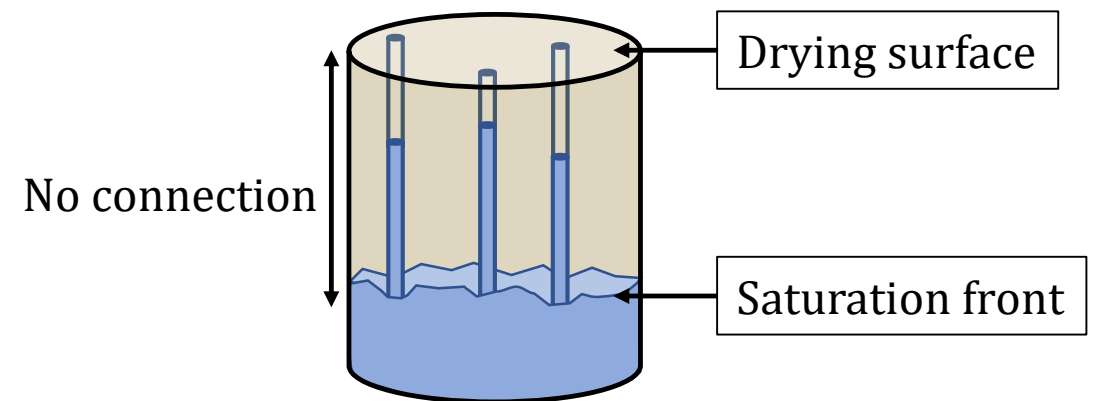
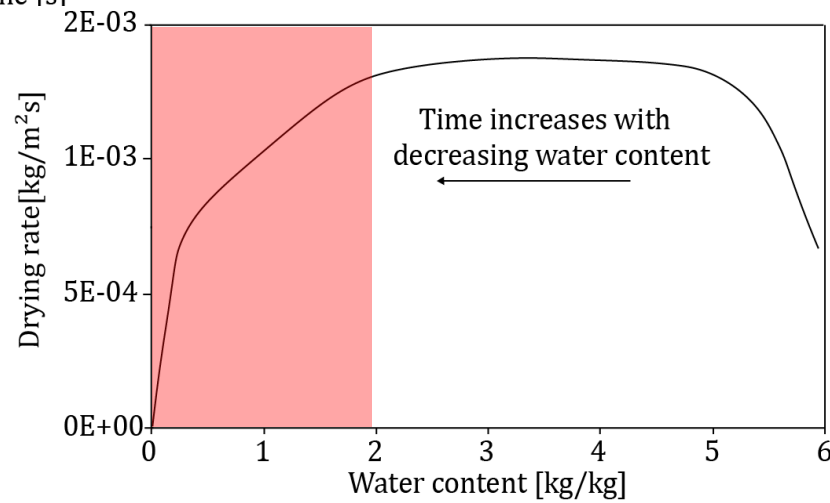
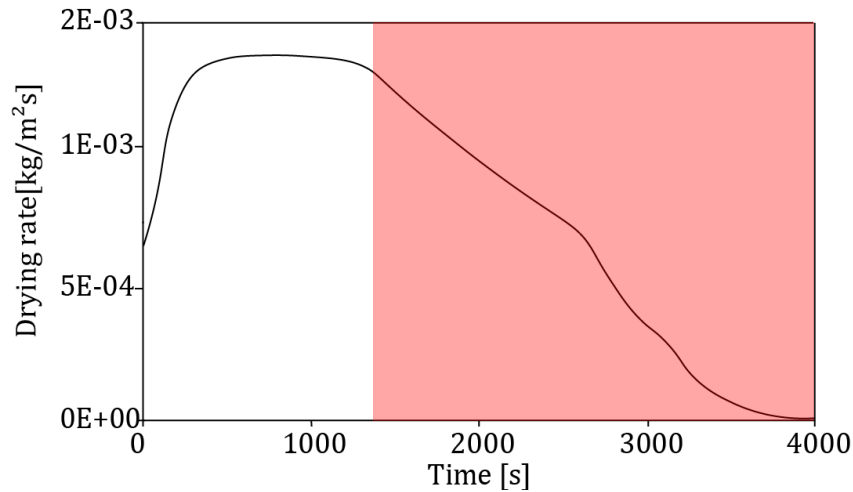
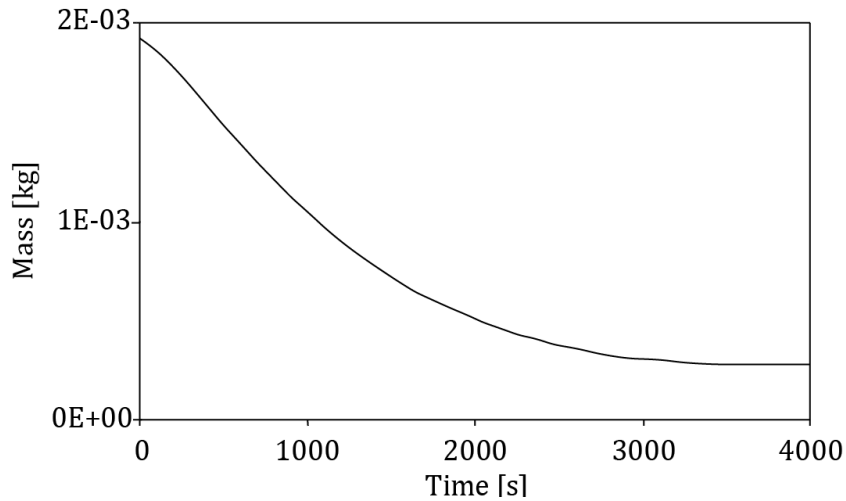

EXPERIMENTAL RESULTS

■ Drying kinetics

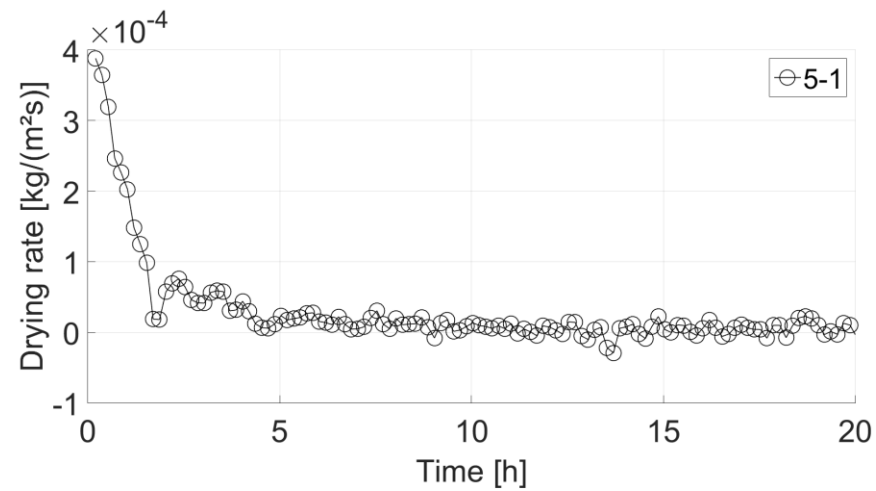
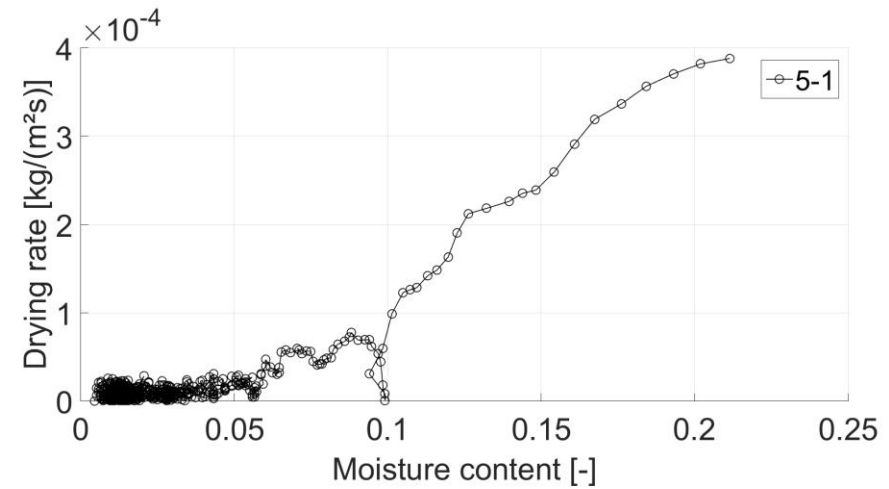
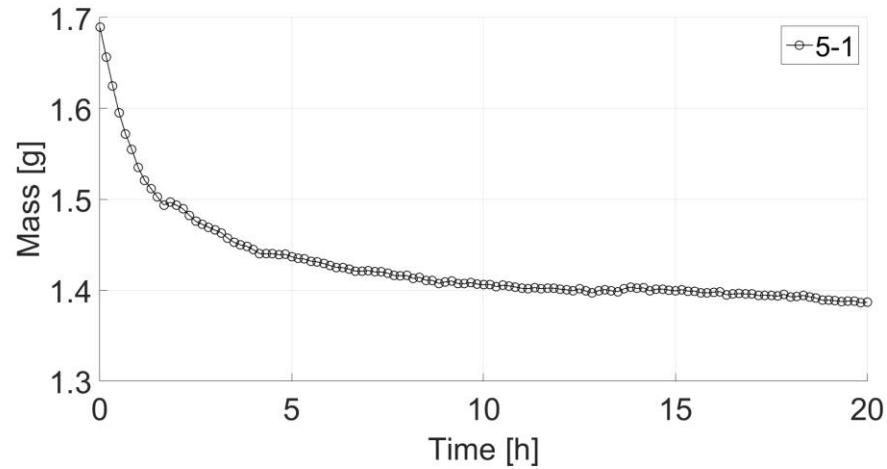

EXPERIMENTAL RESULTS

■ Shrinkage

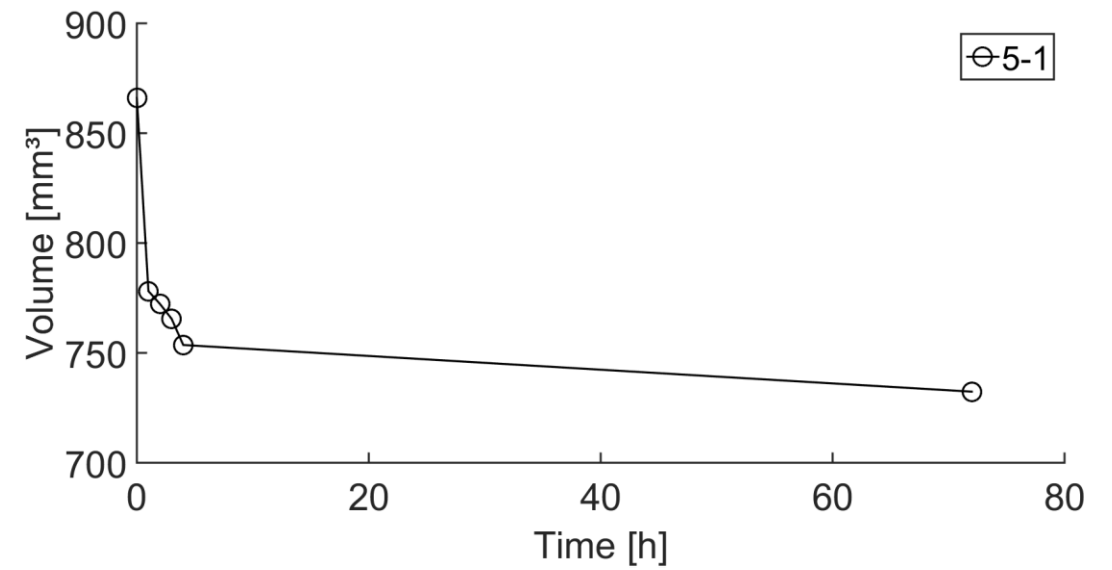
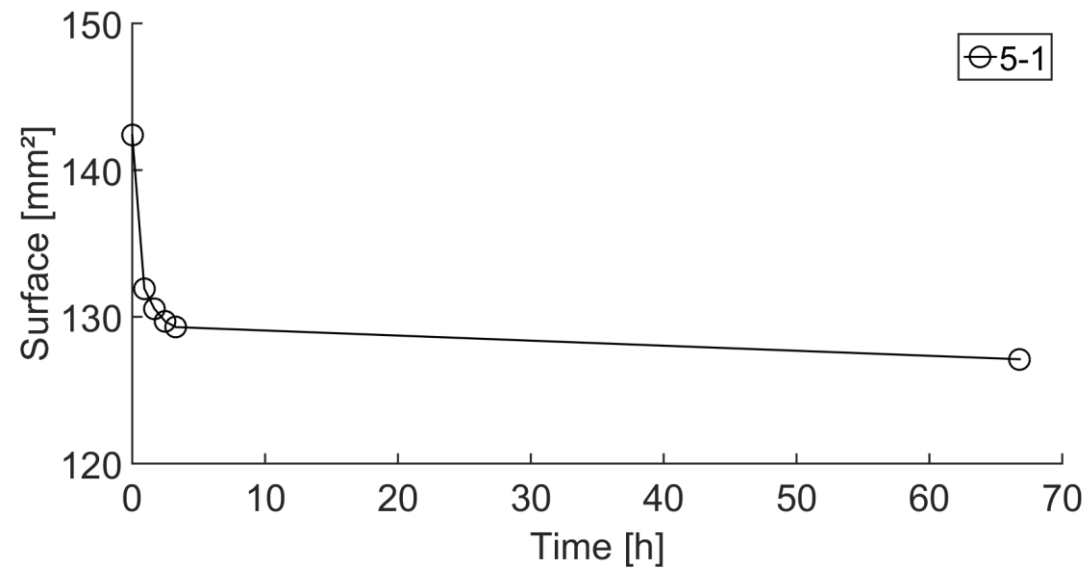

SUMMARY OF THE PRESENTATION

- Scope of the study
- Material and method
- Experimental results
- **Model**
- Numerical results
- Conclusion

MODEL

- Porous medium

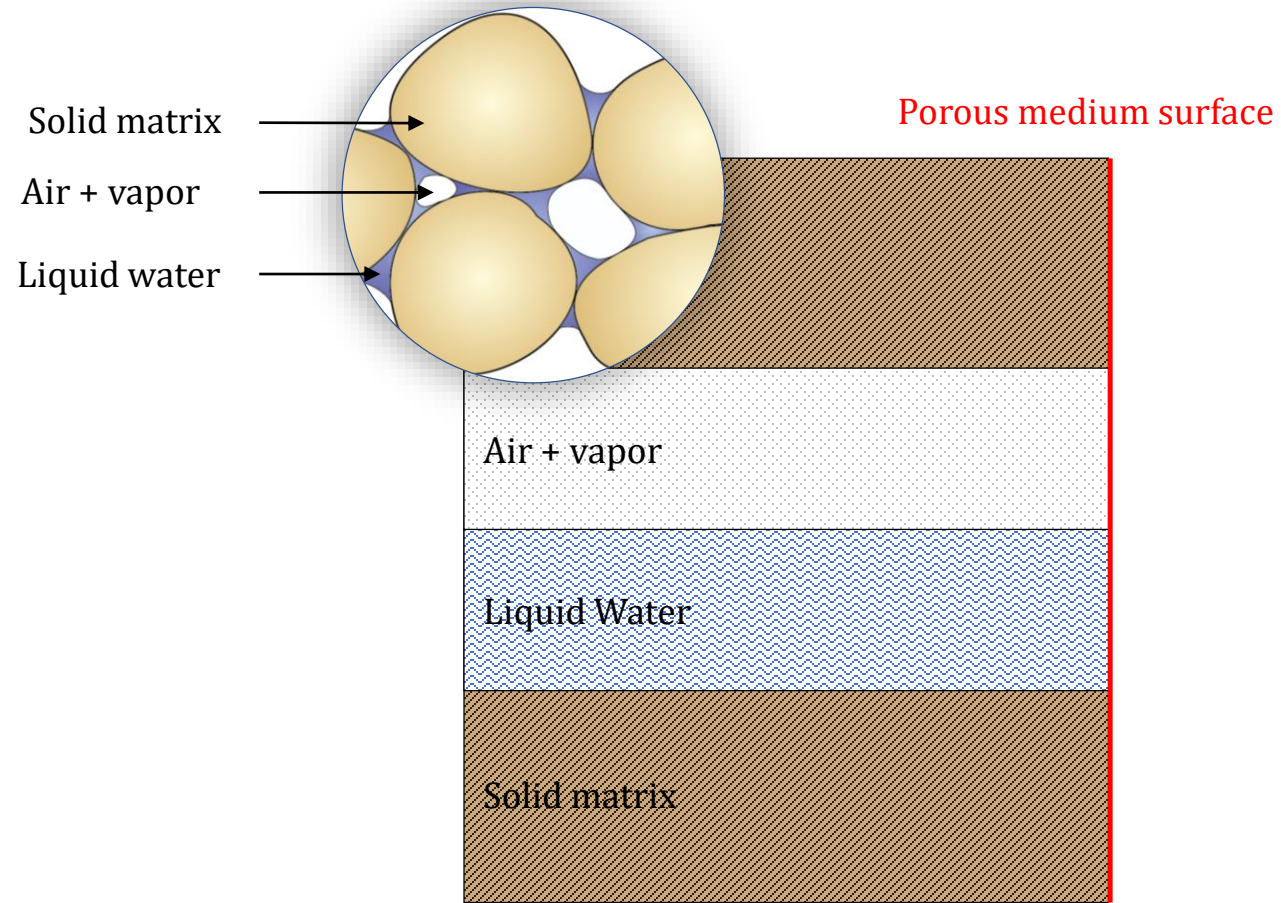

MODEL

- Internal Water transfer

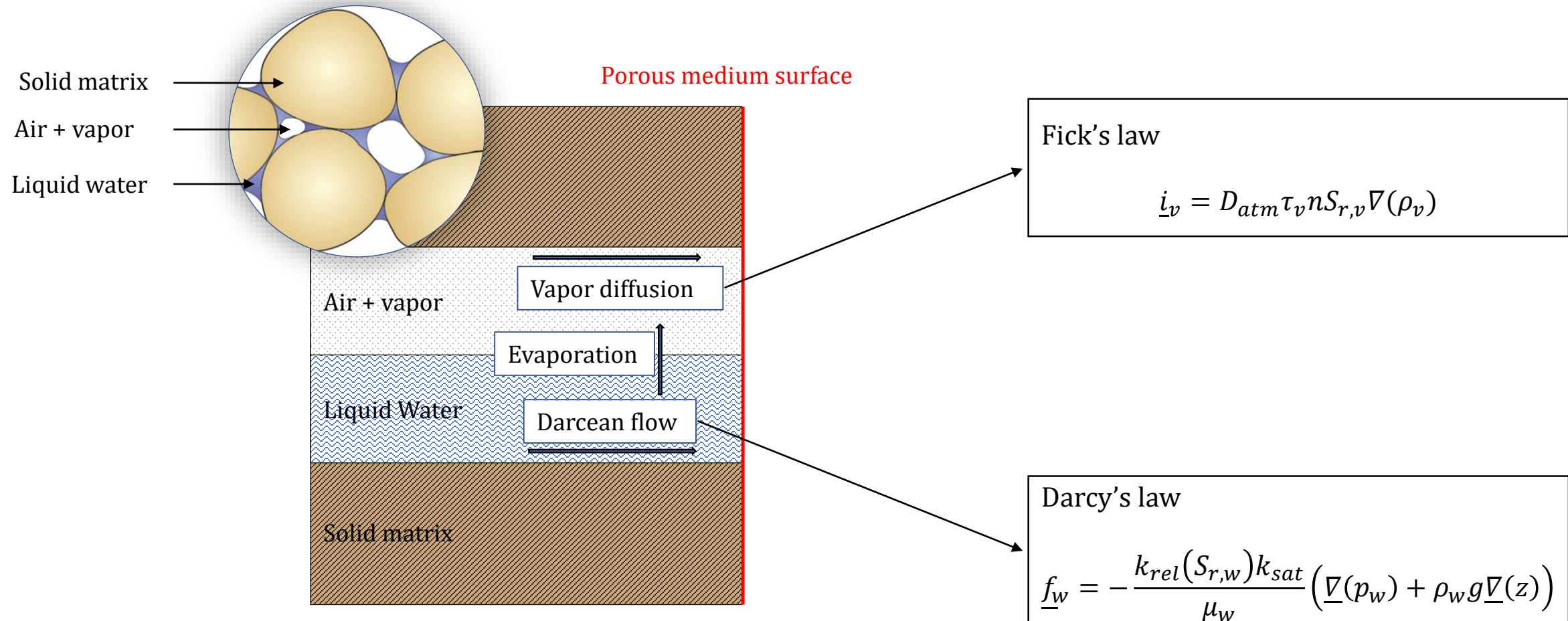

MODEL

- Boundary layer model

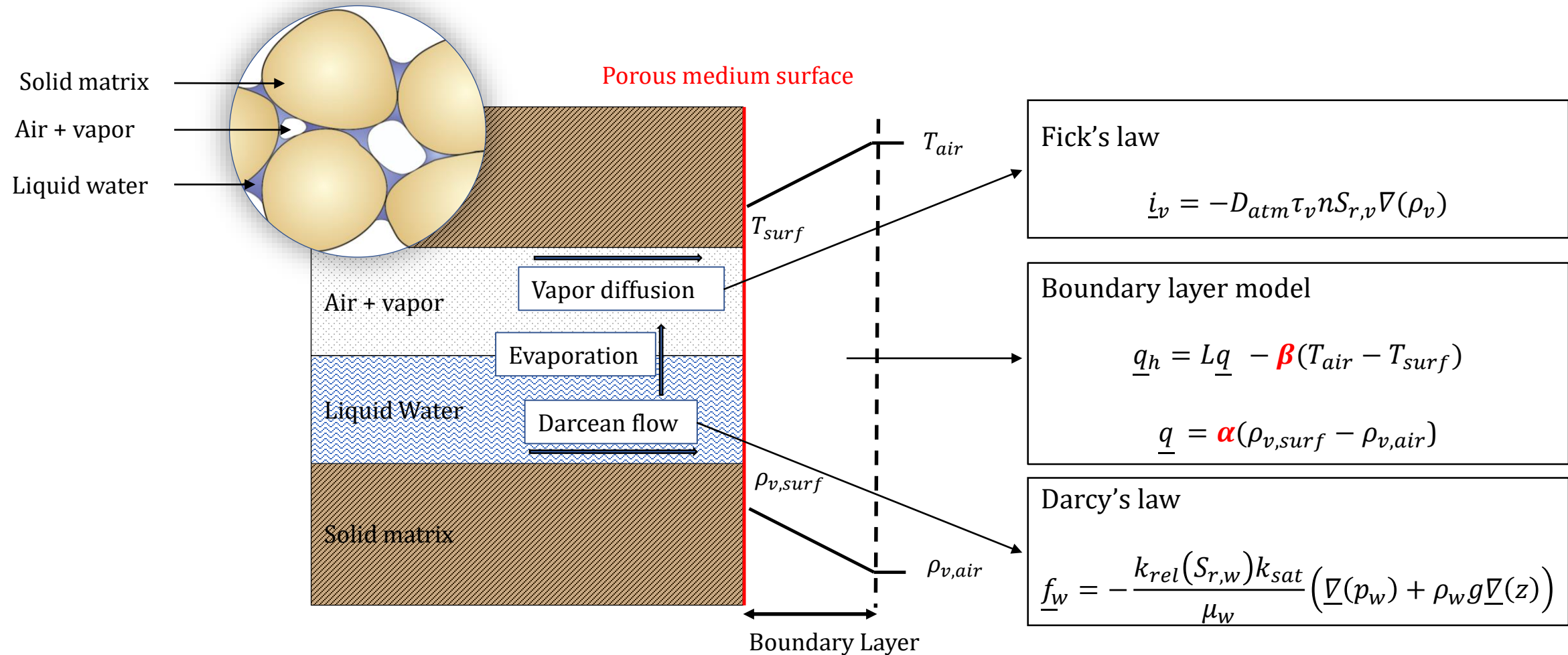

MODEL

- Thermal model

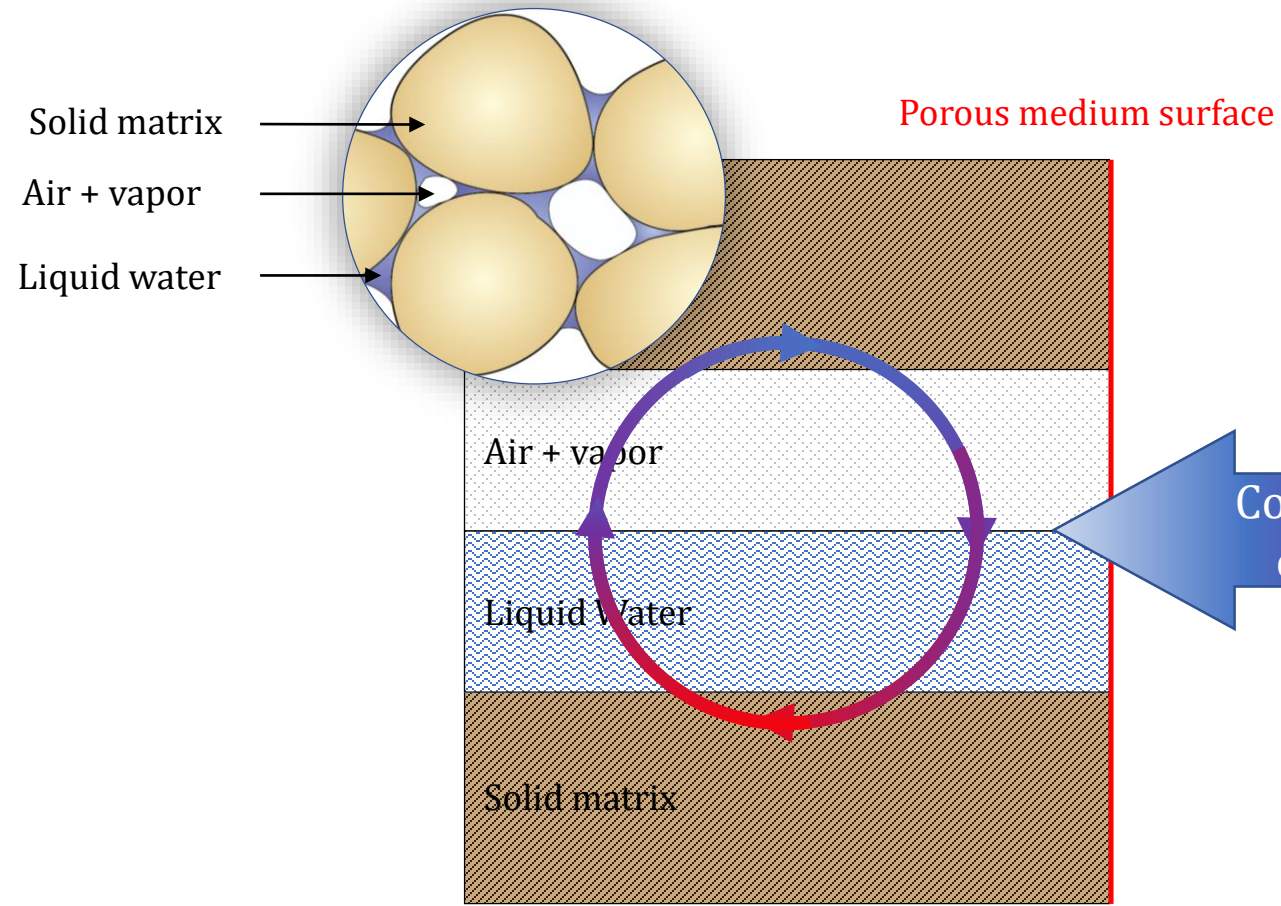

Heat storage

$$S_T = nS_{r,i}\rho_i c_{p,i}(T - T_0) + nS_{r,g}\rho_v L$$

Convection and
conduction

Heat flux

$$V_T = -\Gamma \nabla T + c_{p,i}\rho_i \underline{f}_i(T - T_0) + (\rho_v f_v + i_v)L$$

MODEL

- Mechanical model
 - Expressed in effective stress

$$\sigma'_{ij} = \sigma_{ij} - p_g \delta_{ij} + S_{r,w} (p_g - p_w) \delta_{ij}$$

- 3D orthotropic elastic model

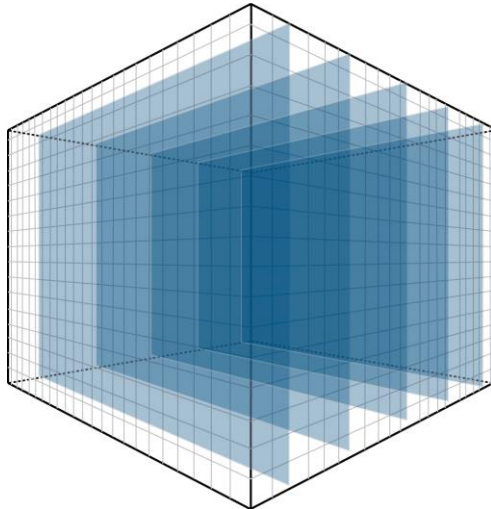

- Non linear elasticity :

$$E = E_0 + E_{ref} \left(\frac{p'}{p_{ref}} \right)^b$$

$$\epsilon_{ij} = D_{ijkl}^e \sigma'_{ij}$$

$$D_{ijkl}^e = \begin{pmatrix} \frac{1}{E_{\parallel}} & -\frac{\nu_{\perp,\parallel}}{E_{\perp}} & -\frac{\nu_{z,\parallel}}{E_z} & 0 & 0 & 0 \\ -\frac{\nu_{\parallel,\perp}}{E_{\parallel}} & \frac{1}{E_{\perp}} & -\frac{\nu_{z,\perp}}{E_z} & 0 & 0 & 0 \\ -\frac{\nu_{\parallel,z}}{E_{\parallel}} & -\frac{\nu_{\perp,z}}{E_{\perp}} & \frac{1}{E_z} & 0 & 0 & 0 \\ 0 & 0 & 0 & \frac{1}{2G_{\parallel,\perp}} & 0 & 0 \\ 0 & 0 & 0 & 0 & \frac{1}{2G_{\parallel,z}} & 0 \\ 0 & 0 & 0 & 0 & 0 & \frac{1}{2G_{\perp,z}} \end{pmatrix}$$

NUMERICAL MODELING

- Meshing and parameters

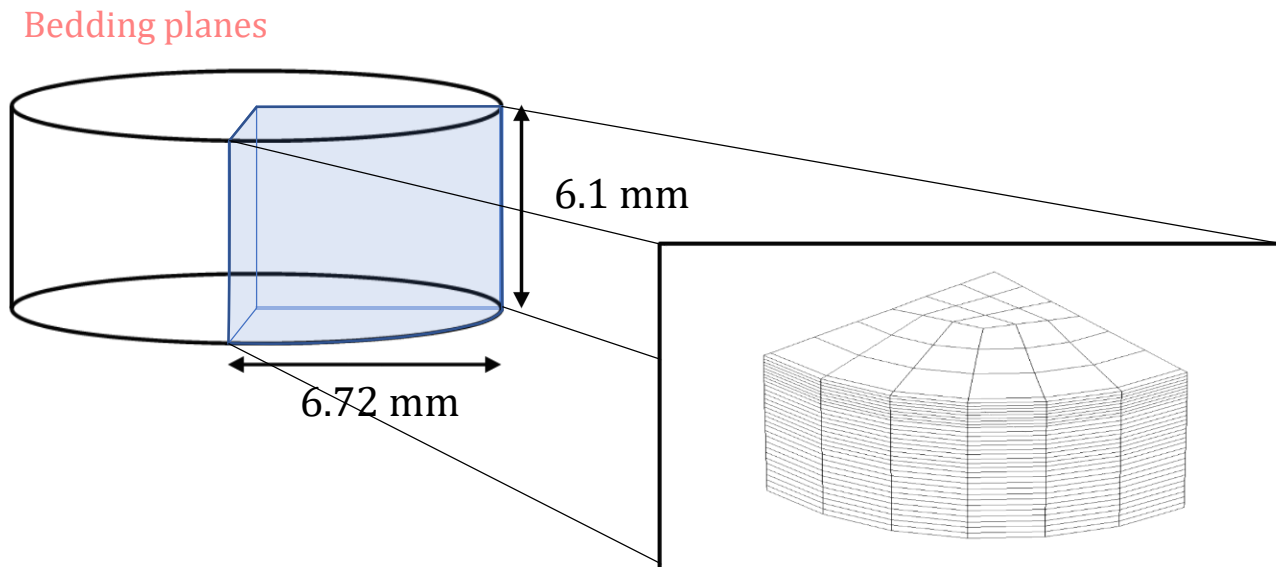

PARAMETERS	VALUES	UNITS
HYDRAULIC PARAMETERS		
$k_{sat,\perp}$	6.10^{-12}	[m/s]
$k_{sat,\parallel}$	3.10^{-12}	[m/s]
n	0.39	[-]
MECHANICAL PARAMETERS		
$E_{\parallel,ref}$	350	[MPa]
$E_{\perp,ref}$	175	[MPa]
$E_{z,ref}$	300	[MPa]
$\nu_{\parallel\perp}$	0.125	[-]
$\nu_{\parallel z}$	0.0625	[-]
$\nu_{\perp z}$	0.0625	[-]
$G_{\parallel\perp}$	140	[MPa]
$G_{\perp z}$	140	[MPa]
ρ_s	2670	[kg/m ³]
THERMAL PARAMETERS		
$c_{p,s}$	2080	[J/kg/K]
ρ_s	2670	[kg/m ³]
$c_{p,w}$	4185	[J/kg/K]
ρ_w	1000	[kg/m ³]
$c_{p,a}$	1004	[J/kg/K]
ρ_a	1.2	[kg/m ³]
$c_{p,v}$	1864	[J/kg/K]
ρ_v	0.59	[kg/m ³]

SUMMARY OF THE PRESENTATION

- Scope of the study
- Material and method
- Experimental results
- Model
- **Numerical results**
- Conclusion

NUMERICAL RESULTS

■ Drying kinetics

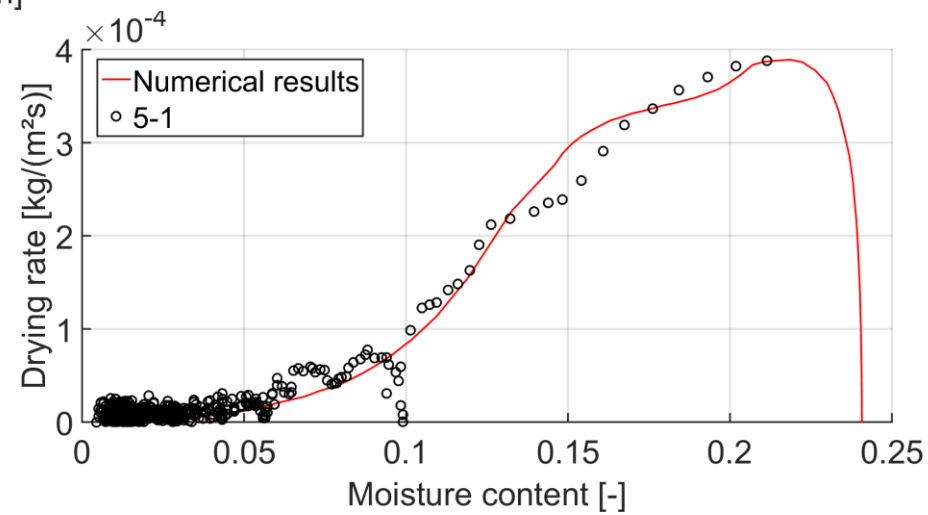
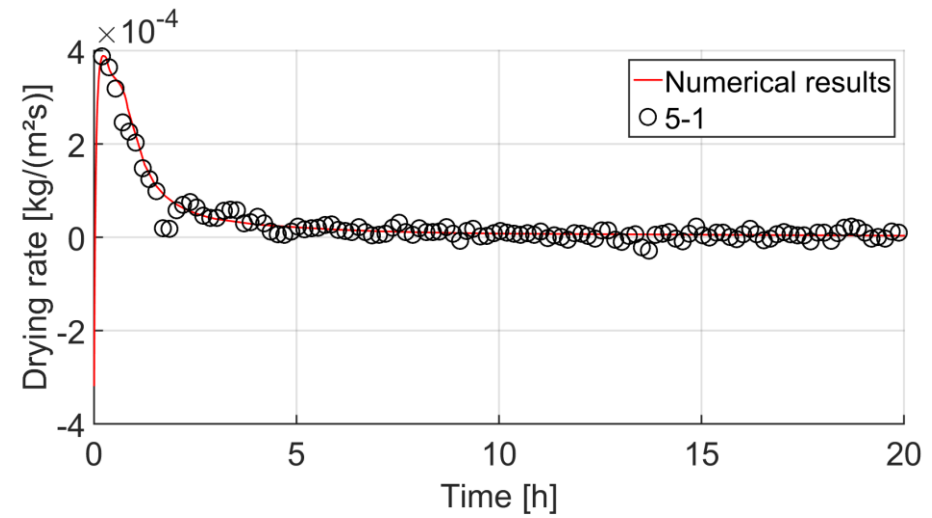
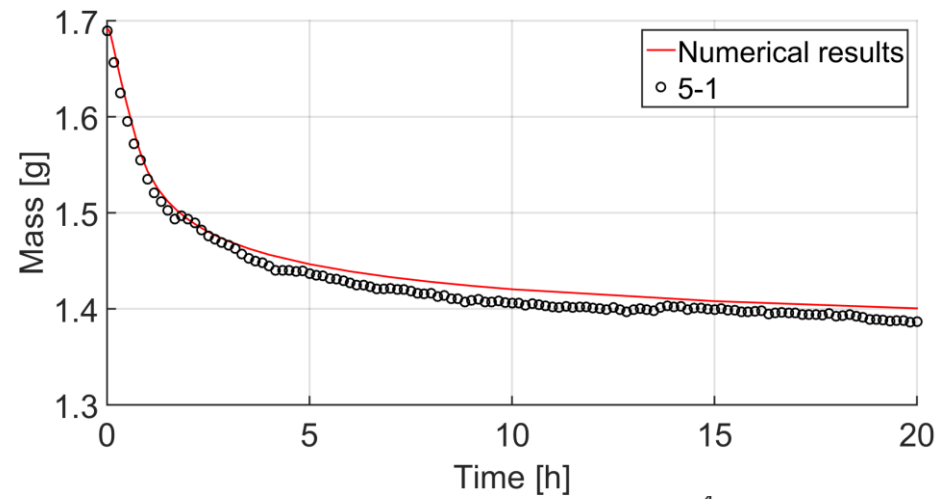

NUMERICAL RESULTS

■ Shrinkage

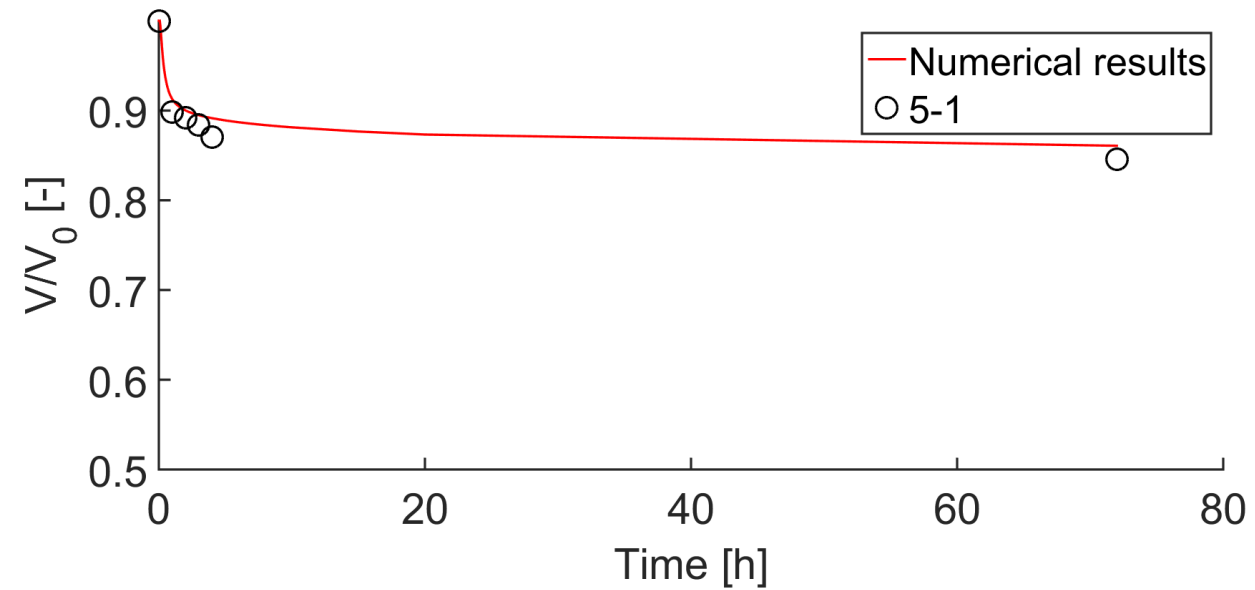
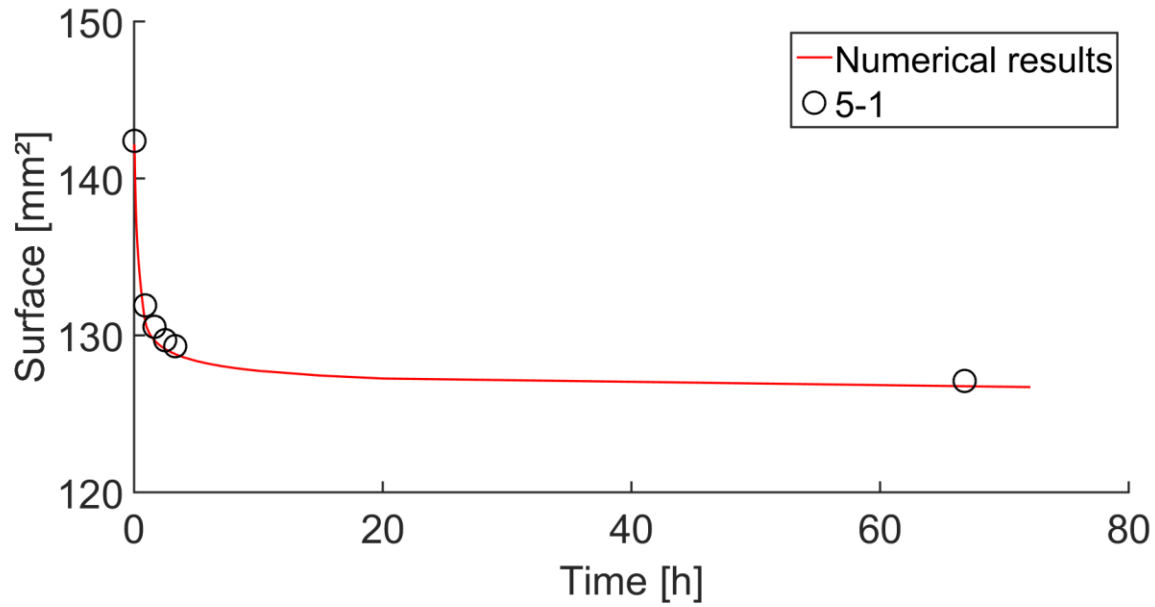

NUMERICAL RESULTS

■ Shrinkage

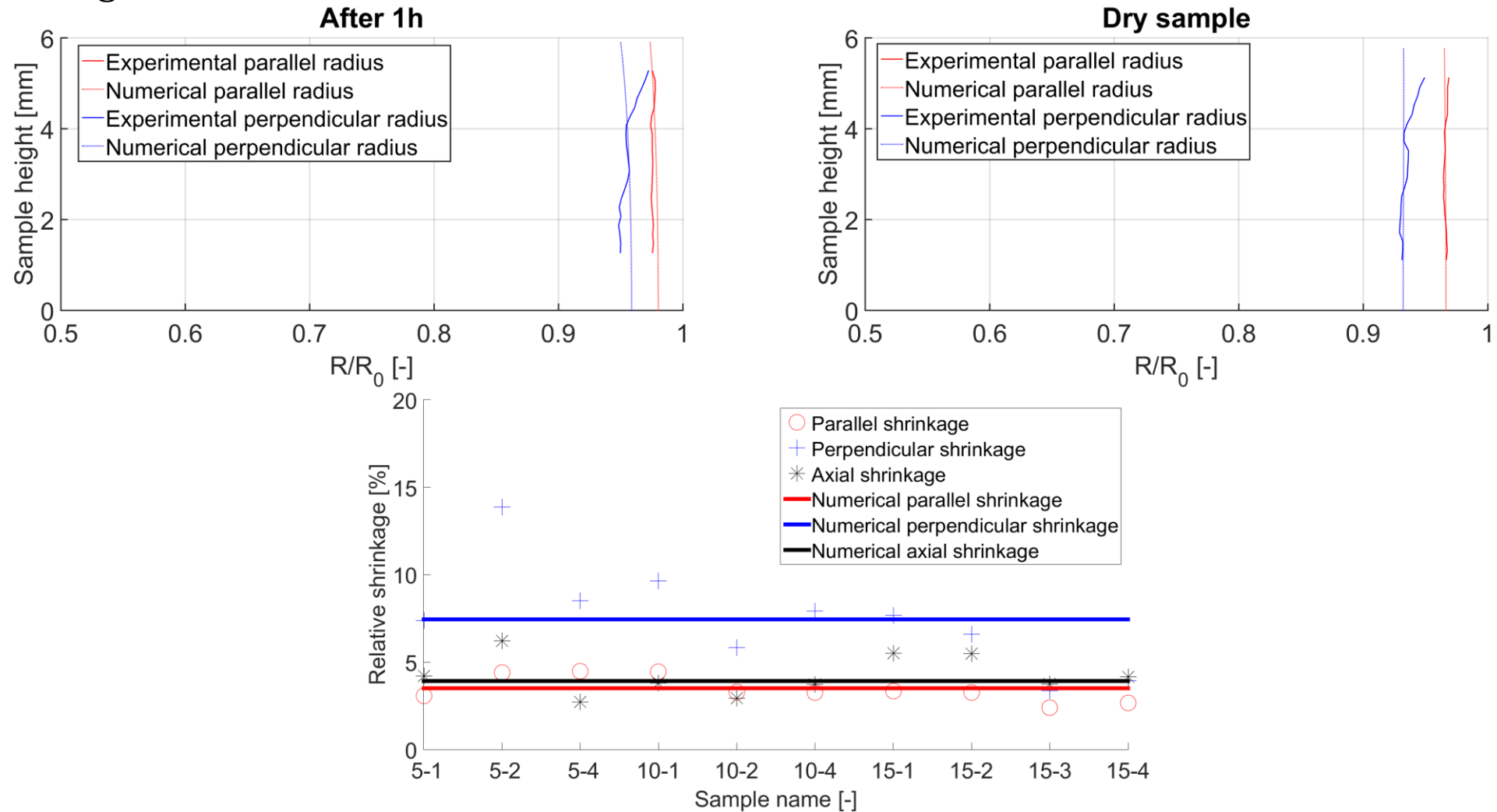

CONCLUSION

- Dessication cracking

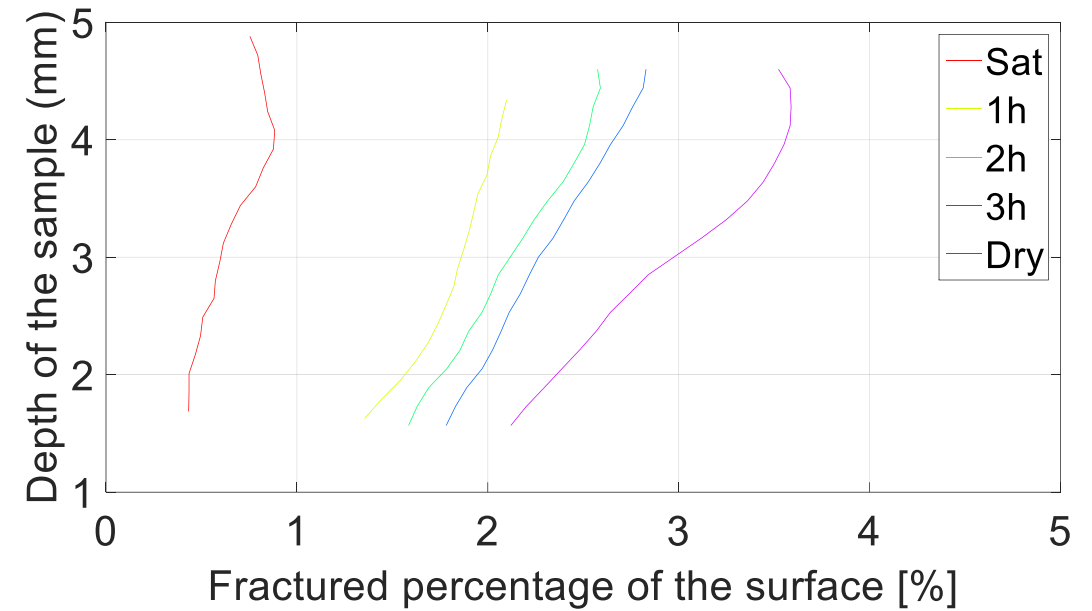
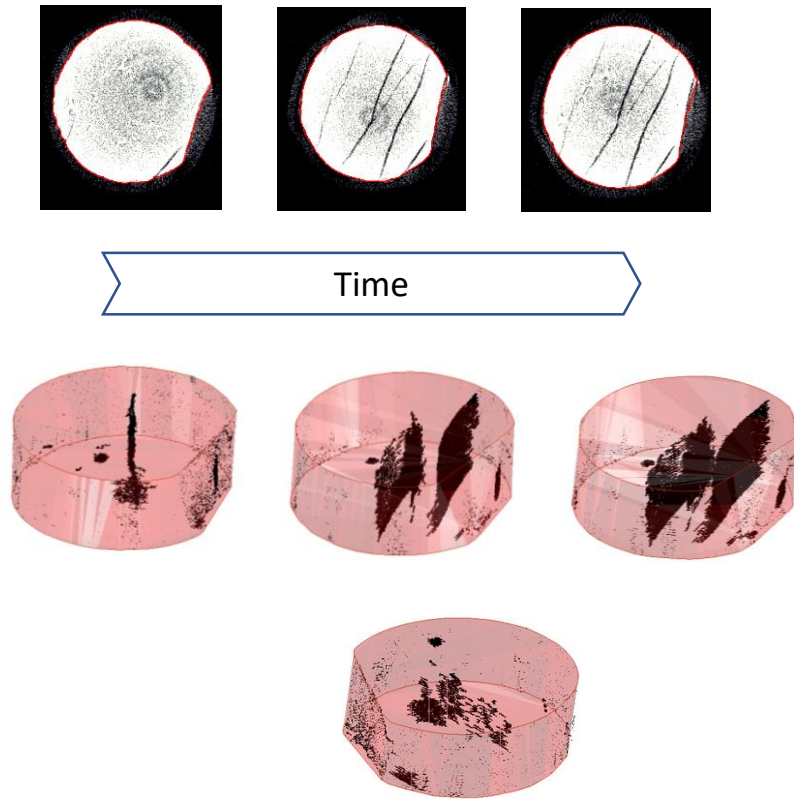

REFERENCES

- Andra (2005a). Dossier 2005 Argile. Synthesis: Evaluation of the feasibility of a geological repository in an argillaceous formation, Meuse/Haute Marne site. Technical report, Paris, France.
- Bastiens W., Demarche M., 2003. The extension of the URF HADES: realization and observation. Proceedings of the WN'03 Conference, Tucson, USA.
- Craeye B., De Schutter G., Van Humbeeck H., Van Cotthem, 2009. *Early age behaviour of concrete supercontainers for radioactive waste disposal*. Nuclear Engineering and Design, 239, 23-35.
- Gerard P., Charlier, R, Chambon, R, & Collin, F. 2008. Influence of evaporation and seepage on the convergence of a ventilated cavity. Water resources research, 44(5), W00C02.
- Léonard A., Étude du séchage convectif de boues de station d'épuration. Suivi de la texture par microtomographie à rayons X. Thèse de doctorat, Université de Liège, Faculté des Sciences appliquées, 2003.
- SCK-CEN. R and D for the geological disposal of medium and high level waste in the Boom clay, 2009. URLence.sckcen.be/en/Projects/Project/RD_waste_disposal/Geological_disposal
- Lehmann, P., Assouline, S., & Or, D. (2008). Characteristic lengths affecting evaporative drying of porous media. *Physical Review E*, 77(5), 056309.

SENSITIVITY STUDY

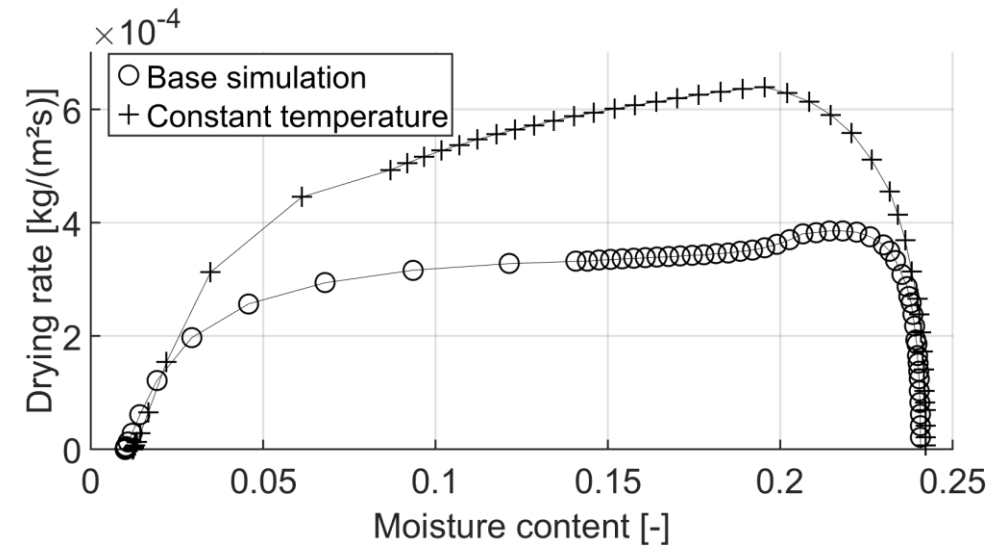
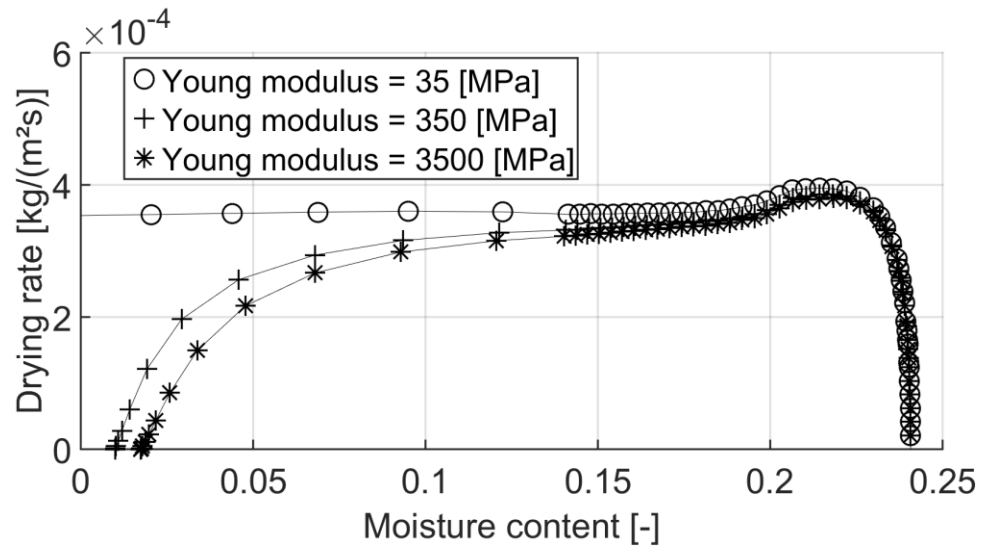
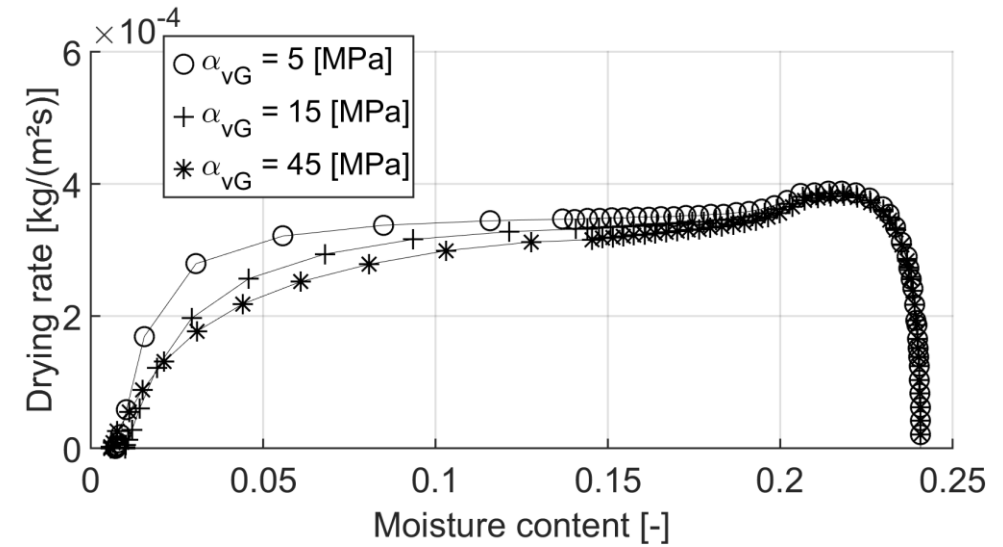
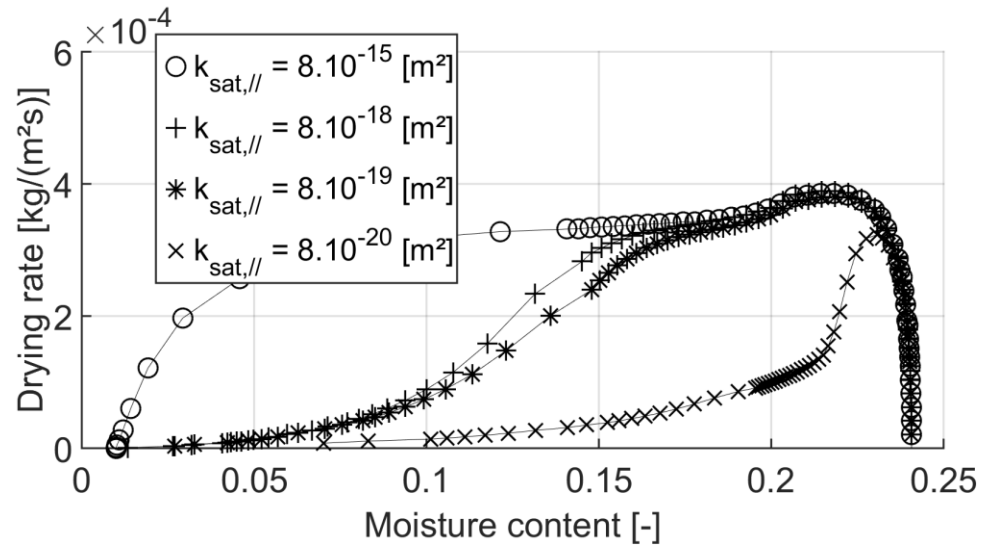

NUMERICAL MODELING

- Boundary layer model in FEM code:

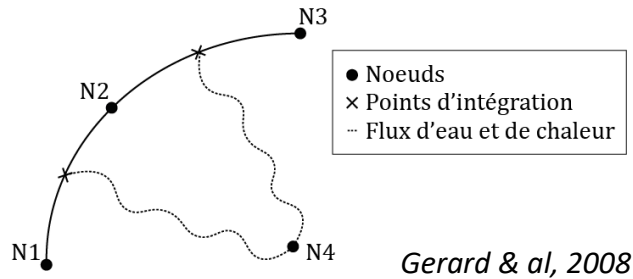

- Water pressure at the environmental node n_4 : $p_c = -\frac{\rho RT}{M} \ln(HR)$
- Temperature at the environmental node n_4 : $T = 25^\circ\text{C}$
- Transfer coefficients:

α [m/s]	β [W/m ² /K]
0.048	53

WATER RETENTION CURVE

- Samples put into chamber with controlled suction (saline solution)
- Water content measured \Rightarrow saturation degree deduced

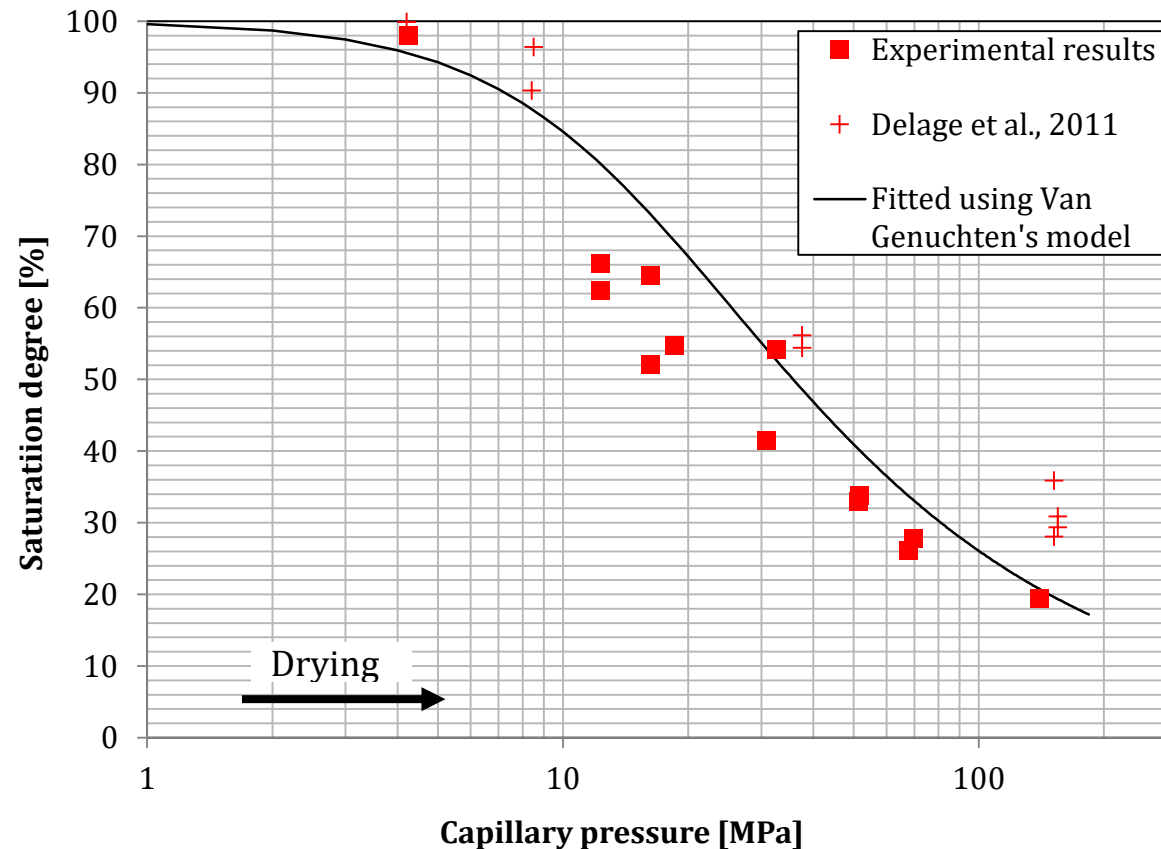

Van Genuchten formulation :

$$S_{r,w} = S_{res} + (S_{sat} - S_{res}) \left[\left(1 + \frac{p_c}{\alpha} \right)^{n_{vg}} \right]^{-m_{vg}}$$

VAN GENUCHTEN FORMULATION		
S_{res}	0	[-]
S_{sat}	1	[-]
α_{vg}	15	[MPa]
m_{vg}	0.449	[-]
n_{vg}	1.70	[-]

BOOM CLAY COMPOSITION

<i>Composition minéralogique en [%]</i>	<i>Al-Mukhtar et al., 1996</i>	<i>Wouters et Vandenberghe, 1994</i>	<i>Decler et al., 1983</i>	<i>Horseman et al., 1986</i>
<i>Quartz</i>	20-25	20	23.8-58.3	30
<i>Interstratifié illite- smectite</i>	33	40-50		
<i>Illite</i>	16	25-35	3-23	19
<i>Smectite</i>			19-42	22
<i>Kaolinite</i>	13	15-25	1-9	29
<i>Feldspaths:</i>		5-10		
<i>Microcline</i>	4-5		6.5-11.3	
<i>Plagioclase</i>	4-5		3.2-6.2	
<i>Chlorite</i>		5-10		
<i>Pyrite</i>	4-5	1-5	0.7-2.5	
<i>Carbonates</i>	traces	1-5	0.0-4.3	
<i>Matières organiques</i>		1-5		

Tableau 3 : Revue bibliographique de la composition minéralogique de l'Argile de Boom

MATERIALS AND METHODS

- X-Ray tomography characteristics
 - Cross section acquisition using a X-Ray microtomography

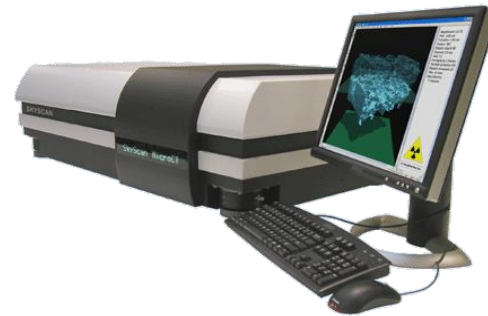

Skyscan 1172

Source Voltage = 100 kV	Filter = Al 0.5 mm	4x4 binning = 900x666 pixel radiograms
Pixel size = 27.27 μm	Exposure time = 510 ms	Rotation Step (deg)= 0.65
180° rotation	2 vertically-connected scans	Scan duration = 8 minutes

EXPERIMENTAL RESULTS

- Numerical filter

