

DUCTILITY REQUIREMENTS FOR THE DESIGN OF BOLTED SHEAR CONNECTIONS

J. Henriques¹, J. P. Jaspart² and L. Simões da Silva³

¹ISISE, University of Coimbra, Civil Engineering Department, Coimbra, Portugal

²University of Liège, ArGEnCo Department, Liège, Belgium

³ISISE, University of Coimbra, Civil Engineering Department, Coimbra, Portugal

Abstract: The resistance of shear bolted connections is traditionally evaluated by considering an equal distribution of internal forces amongst the bolts. In fact, such an assumption may only be seen as the result of a plastic redistribution of the internal forces, what requires shear ductility in the vicinity of the bolts. In the present paper, ductility requirements are proposed that ensure that, in the presence of real imperfect bolted shear connections, plastic resistance can be attained.

Keywords: Shear bolted connections, equivalent bolt zone component, available deformation capacity, required deformation capacity, ductility criteria.

1. Introduction

A connection can be classified as a Shear Bolted Connection when the forces transferred between the elements induce pure shear in the bolts. Two types of shear connections, also called lap connections, may be found: single and double overlap connections. The difference consists in the number of shear planes that cross the bolt shanks (Figure 1).

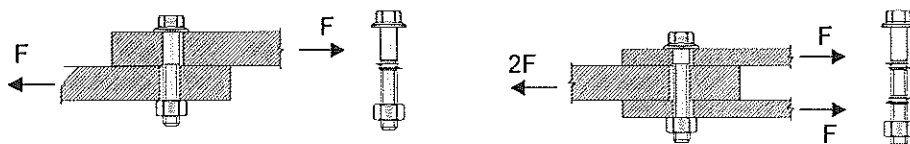

Figure 1 –Single and double overlap connections.

In shear bolted connections, two different elements may be distinguished: connectors (bolts) and connected elements (plates). The term plate is used to refer to column flanges, beam flanges, beam webs, splice plates, etc.

When a bolted connection is submitted to shear, forces are transferred from one plate to the other (others) by plate-to-bolt contact. Neglecting the small friction developed between the plates and the negligible bending of the bolt, four different resistance and deformation modes should be considered:

- Bearing of the plate and/or bolt;
- Shear in the plates;
- Tension in the plates;
- Shear in the bolt shanks.

From these, the behaviour of a shear bolted connection can be defined by the response of two different parts: bolt zone, where bearing and shear forces develop; and the plate between holes where direct forces develop in the plate. The work presented in this article focuses on the bolt zone; so the failure of the connection by excess of tension in the connected plates is here not considered.

In these types of connections, the load to be transferred between the plates is distributed non-uniformly amongst the bolt-rows (Figure 2a), Ju et al. [9]. If sufficient deformation is provided around each connector, a full plastic redistribution of forces may be noticed, otherwise failure is reached by lack of ductility and the maximum external force to be transferred is lower than the one corresponding to a full plastic distribution. Schematically, the different stages of forces distribution in a shear bolted connection may be represented as in Figure 2.

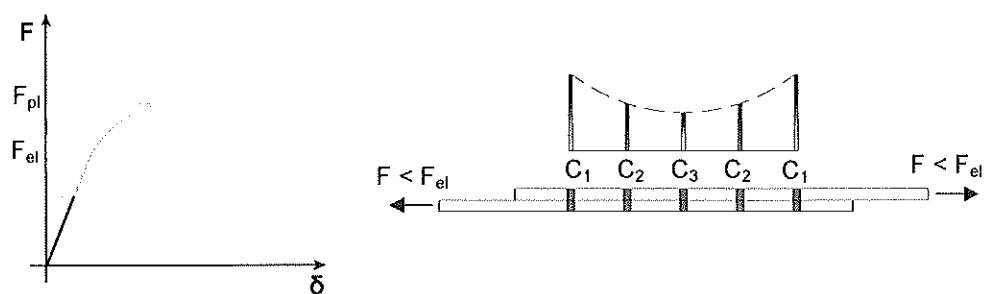

a) None of the bolt rows yield;

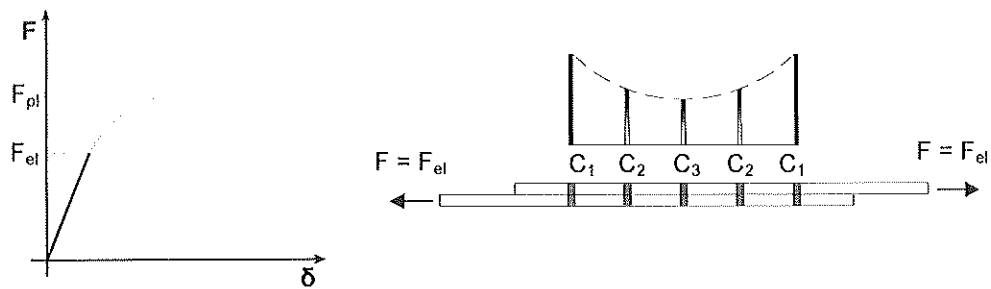

b) Outer bolt rows yield (elastic resistance of the connection);

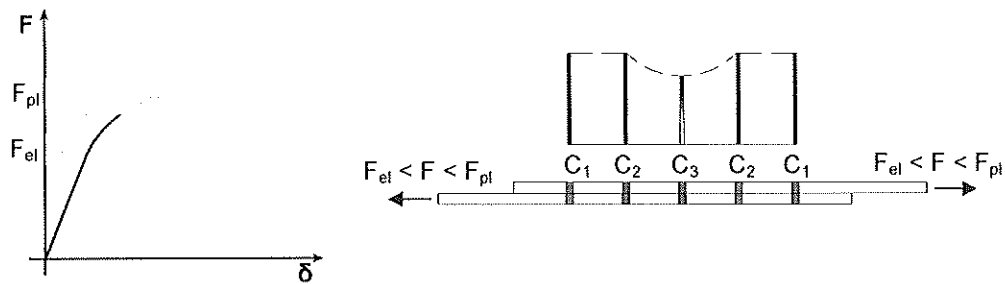

c) Progressive yielding of bolt rows from outside to inside

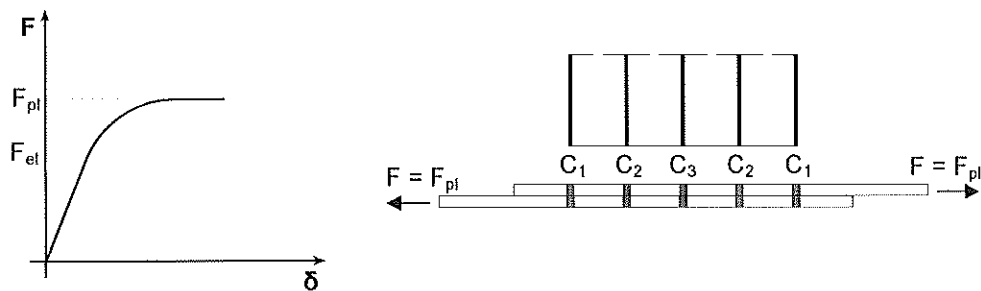

d) All bolt rows yield (full plastic resistance of the connection)

Figure 2 –Different stages of force distribution in shear bolted connections.

In the same study, Ju *et al.* [9] showed that in the nonlinear range the maximum load achieved by the connection is almost linearly proportional to the number of bolts arranged in the connection. In part 1-8 of Eurocode 3 [1], a full plastic distribution of forces can be assumed as long as the connection length is limited.

Pietrapetrosa *et al.* [15] approached the subject by only considering fitted bolts. Their study showed that, inside the limits given by the code and by practical guidance, sufficient ductility to achieve a full plastic distribution of internal forces is available. However, the common

practice is the use of non fitted bolts and the presence of imperfections is also a reality. Consequently, the lack-of-fit will increase the demands of ductility as some bolts bear before the others, as verified by Wald *et al.* [16]. They showed that for certain values of gap in some bolt rows, failure was first attained in the extreme bolts and therefore a full plastic resistance was not reached.

Based on the principles of the component method, it is the objective of the present paper to derive general formulae to determine the deformation capacity required in the bolt zone components that allows to reach, in actual shear bolted connections, full plastic resistance.



2. Eurocode 3 design procedure for bolted connections in shear

Part 1.8 of Eurocode 3 [1] is dedicated to the design of joints in steel structures. It prescribes the component approach for the evaluation of the mechanical properties of the joints, Jaspart [10] and Weynand *et al.*, [17]. However, the analysis of shear bolted connections is not specifically treated, although the code gives recommendations for the evaluation of the stiffness and resistance properties of several individual components. According to the principles of the component method, it is up to the designer to identify the relevant components and to assemble them according to a representative mechanical model in order to be able to predict the response of the whole connection.

According to the classification system for joints in Eurocode 3 part 1.8 [1], the connections considered here belong to category A: Shear Bolted Connections – Bearing Type. These ones resist by transferring forces through plate/bolt contact and bolt shearing. Non preloaded bolts are used and the small friction resistance between the contact surfaces is neglected. Considering the resistance and deformation modes listed in the introduction and that are relevant for shear bolted connections, among the list of individual components presented in Table 6.1 of part 1.8 of Eurocode 3 [1], the following should be considered: bolt in shear, plate/bolt in bearing and plate in tension. Furthermore it is then assumed that the failure mode of a bolt zone (i.e. a zone where a shear force is locally transferred from one plate to another) is associated to that of the weakest component. Through this procedure, the resistance and stiffness properties of the bolt zone may so be evaluated. It is noted, however, that part 1.8 of

Eurocode 3 gives no information on the deformation capacity of these components. Table 1 summarises the characterization of the relevant components.

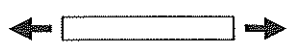
Table 1 – Eurocode 3 expressions to evaluate the characteristic resistance (R_c) and the stiffness (S_c) of the basic components.

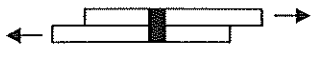
		S_c	R_c
Plate in tension		$S_{pl} = EA/p_b$	$R_{pl} = \min(A f_y; 0,9 A_{net} f_u)$
Bolt in shear		$S_b = 8 d^2 f_{ub}/d_{M16}$	$R_b = \alpha_v f_{ub} A_b$
Plate in bearing		$S_p = 12 k_b k_t d f_u$	$R_p = k_1 \alpha_b f_u d t$
Equivalent component		$(S_b^{-1} + S_{p1}^{-1} + S_{p2}^{-1})^{-1}$	$R_{eq} = \min(R_b, R_{p1}, R_{p2})$
E	Young Modulus	d	diameter of the bolt
A	gross area of the plate	$d0$	diameter of the bolt hole
A_{net}	net area of the plate	d_{M16}	nominal diameter of a M16 bolt
p_b	pitch distance ($//$ to load transfer)	e_2	edge distance (\perp to load transfer)
e_b	end distance ($//$ to load transfer)	p_2	pitch distance (\perp to load transfer)
f_y	yield strength of the plate	k_b	$= \min(k_{b1}, k_{b2})$
f_u	ultimate strength of the plate	k_{b1}	$= 0,25 e_b/d + 0,5$ but $k_{b1} \leq 1,25$
t	thickness of the plate	k_{b2}	$= 0,25 p_b/d + 0,375$ but $k_{b2} \leq 1,25$
A_b	shear area of the bolt (nominal or area)	stress k_t	$= 1,5 t / d_{M16}$ but $k_t < 2,5$
f_{ub}	ultimate strength of the bolt	α_v	$= 0,5$ or $0,6$
		α_b	$= \min(e_b/3d0; p_b/3d0 - 0,25; f_{ub}/f_u; 1,0)$
		k_1	$= \min(2,8 e_2/d0 - 1,7; 1,4 p_2/d0 - 1,7; 2,5)$

The evaluation of the response of a shear bolted connection (Figure 3a) by assembly of the relevant components is accurately obtained using the mechanical model of Figure 3b, Pietrapetrosa *et al.* [15] and Greisnigt *et al.* [5]. Each individual component is modelled through extensional springs. In the bolt zone, one observes that three springs act in series: the bolt in shear (S_b); and twice the plate/bolt in bearing (S_{pi}). Assembling these three springs into an equivalent spring S_{eq} (describing the bolt zone response) leads to the simplified model of Figure 3c where the components at the bolt zone are represented by a so-called equivalent bolt zone component (Table 1).



a) Shear connection with three bolts



b) Actual mechanical model

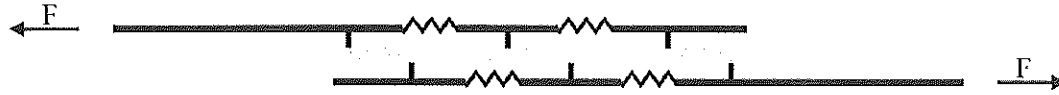

c) Simplified mechanical model

Figure 3 – Mechanical models

For shear connections with more than one bolt zone "in length", two recommendations given by the code are relevant. The first is related to the resistance of connections with a limited number of bolt zones along the length:

$$\begin{cases} \text{if } F_{v,Rd,i} \geq F_{b,Rd,i} \quad \forall i \Rightarrow F_{Rd} = \sum F_{b,Rd,i} \\ \text{if not } F_{Rd} = n \min \{ F_{Rd,i} \} \quad \text{with } F_{Rd,i} = \min(F_{v,Rd,i}; F_{b,Rd,i}) \end{cases} \quad (1)$$

where:

- F_{Rd} is the resistance of the whole connection;
- n is the number of bolt zones "in length";
- i indicates the bolt zone number;
- $F_{b,Rd,i}$ and $F_{v,Rd,i}$ are, respectively, the bearing and the shear resistances of bolt zone i .

The second rule is related to long joints where the shear resistance should be reduced if the connection length (L_j) exceeds 15d. In this case, the following reduction factor should be applied to the shear resistance ($F_{v,Rd}$) of the bolts:

$$\beta_{Lj} = 1 - \frac{L_j - 15d}{200d} \quad \text{but } 0.75 \leq \beta_{Lj} \leq 1.0 \quad (2)$$

3. Evaluation of imperfections/lack of fit

As in every construction type, imperfections related to fabrication have to be considered in steel structures. As far as the response of shear connections is concerned, the discrepancy between the nominal and the actual values of bolt diameters, hole diameters and positions (pitches and end distances) may affect the behaviour of the connections as the imperfections will lead to a non simultaneous transfer of forces between the bolts, as it would be the case for "perfect" connections (for instance, connections with fitted bolts).

Values of tolerances are given in the European Standard for the Execution of Steel Structures and Aluminium Structures, EN 1090-2 [2], in ISO/DIS 4759-1 [7] and in ISO286-2 [8]. Based on these values, the lack of fit in bolted connections may be quantified. However, due to the multiple parameters involved, this task is complex. In order to simplify, and have in consideration the evaluation of the maximum required deformation in a bolt zone, some assumptions are established in order to get the "worst situation" (i.e. the one for which the highest demand in terms of ductility is required from a bolt zone):

- Possibility to have different values of actual hole diameters in every plate;
- Possibility to have different hole deviations in every plate, and consequently different values of pitch and end distances in every plate;
- The bolt initially in contact with the plates is one of the outer bolts (henceforth this bolt will be designated as FBW [First Bolt Working], while the notation RB [Rest of the Bolts] will be used for all the others), this allows to maximise the requested deformation capacity for the FBW bolts;
- The "worst situation" results from the combination of all these possibilities. Even if this is not the more realistic pattern, it could anyway happen; and for sure it is the one leading to the highest request in terms of ductility.

Using the standards values for tolerances and the previous assumptions, several connection layouts may be drawn to identify the "worst case", as illustrated in Figure 4.

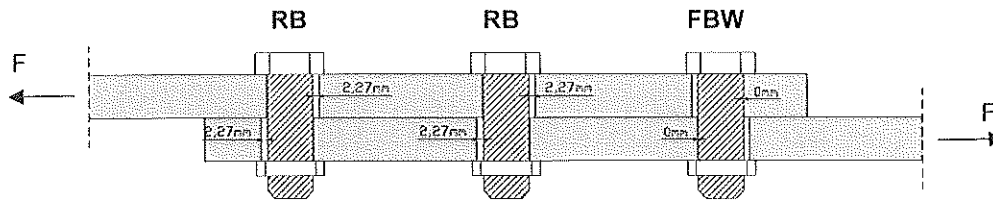

Figure 4 – Connection layout considering the presence of imperfections.

Analysing several situations, as different bolt diameters, one obtains the gaps to be considered in a bolted connection that respect the previous assumptions. Table 2 presents maximum gaps that may be observed in a connection layout according to the bolt diameter used. The main factors which distinguish the different values obtained are the hole clearance and the tolerances allowed by standards, for different bolt diameters.

Table 2 – Gaps in bolted connections

Bolts	2, 3 or more bolts		
	FBW gap	RB gap	Max. Gap
M12-M14	0.00	3.08	3.08
M16	0.00	4.54	4.54
M18-M24	0.00	4.66	4.66
M27	1.00	5.66	4.66
over	1.00	5.78	4.78

4. Response of the individual components

As mentioned before, two different individual components interact in the bolt zone: the bolt in shear and the plate/bolt in bearing. And in order to analyze shear bolted connections, the behaviour of these components has first to be predicted. Hereafter, code recommendations and results of former investigations are used to achieve it.

4.1 Bolt in Shear

In Moscow, Karmalin *et al.* [12] have performed numerous experimental tests on bolts in shear. Resistance, stiffness and deformation capacity of bolts subjected to shear have been measured for M16, M20 and M24 with grades 5.8, 8.8 and also for bolts with a minimum tensile strength equal to 1100 MPa (high strength). The tested specimens consisted of single bolted connections with two-shear planes, see Figure 5. Table 3 presents the test results.

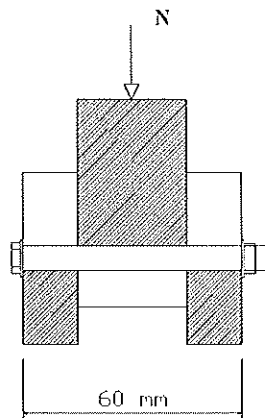

Figure 5 – Test set-up of Moscow experiments.

Table 3 – Moscow test results

Bolts Grade	$R_{u,b}$ [kN]			$\delta_{u,b}$ [mm]		
	M16	M20	M24	M16	M20	M24
5.8	63 – 72	97 – 110	137 – 150	2.9 – 3.4	3.4 – 3.8	4.1 – 4.4
8.8	81 – 93	124 – 141	175 – 193	2.2 – 2.5	2.6 – 3.0	3.1 – 3.5
High-strength	126 – 150	195 – 220	275 – 308	1.6 – 2.0	1.8 – 2.2	2.1 – 2.7

Based on the EC3 part 1.8 [1] expressions (see Table 1) and on these experimental results, expressions to determine the ultimate deformation capacity, ultimate resistance and strain-hardening stiffness of bolts in shear have been derived. With the aim to refer explicitly to Eurocode 3, the here-above listed parameters are expressed as a function of the initial stiffness (S_b) and of the nominal resistance (R_b)(see Table 1). Table 4 presents these expressions. A detailed derivation being found in Henriques thesis [6].

Table 4 – Ultimate resistance, ultimate deformation capacity and strain-hardening stiffness for the “bolt in shear” component.

Bolts Grade	$\delta_{u,b}$			$S_{st,b}$	$R_{u,b}$
	M16	M20	M24		
5.8	4.7 R_b/S_b	5.5 R_b/S_b	6.7 R_b/S_b	$S_b/2.5$	1.58 R_b
8.8	3.0 R_b/S_b	3.5 R_b/S_b	4.2 R_b/S_b	$S_b/7.0$	1.05 R_b
High-strength	2.6 R_b/S_b	2.9 R_b/S_b	3.4 R_b/S_b	$S_b/1.5$	1.44 R_b

4.2 Plate/bolt in bearing

Bearing problems are complex as they deal with contact between two bodies. The development of a numerical model for the simulation of bearing phenomena was carried out using the Lagamine code [13], a software developed at the ArGENCo Department of the University of Liège. Available tests made in other universities were used to calibrate the numerical model: tests on shear bolted connections at the University of Ljubljana [14] and at the Technical University of Delft [4].

The idealized numerical model consisted in a plate with a hole fixed in one edge (width edge) and free in all the others. In the hole was placed a rigid element which simulated the bolt. This element is “pulled” against the plate in the opposite direction of the supports. Figure 6 illustrates the idealized model.

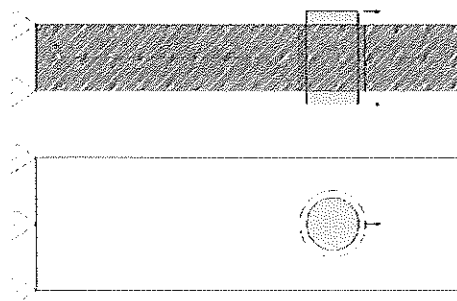

Figure 6 – Idealized model for bearing.

The plate was modelled using 3D volume elements (BLW3D) available in LAGAMINE. This element is defined by 8 nodes and 1 Gauss integration point. The bolt was modelled as a rigid body (FOUNDATION). As in the experiments, double overlap connections have been tested, only part of the external plates has been modelled. The confinement effect provided by these plates has been simulated, but only in the region where its influence is relevant, see Figure 7. For these plates the same type of 3D volume elements has been used. Finally, to model the contact, plane elements (CIF3D) able to simulate three-dimensional mechanical contact problems were used. This element is composed by 4 nodes and 4 Gauss integration points. Two contact zones have been defined: bolt – plates contact; main plate – external plate contact.

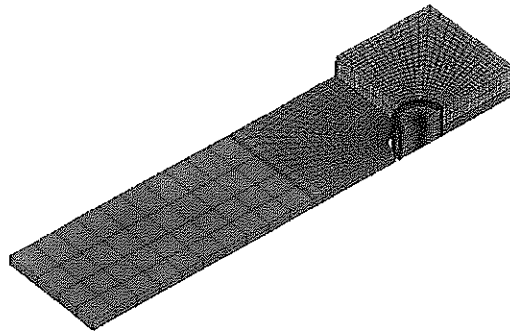

Figure 7 – Model with cover plate.

One of the main objectives was to be able to model bearing failure; this goal was not completely achieved. As one can see, as an example, in Figure 8, for one of the tested specimens, the numerical model can rather well approximate the whole connection behaviour, but no reliable failure criterion, indicating when the simulation should be stopped, has been finally identified. Further related investigations are therefore still needed.

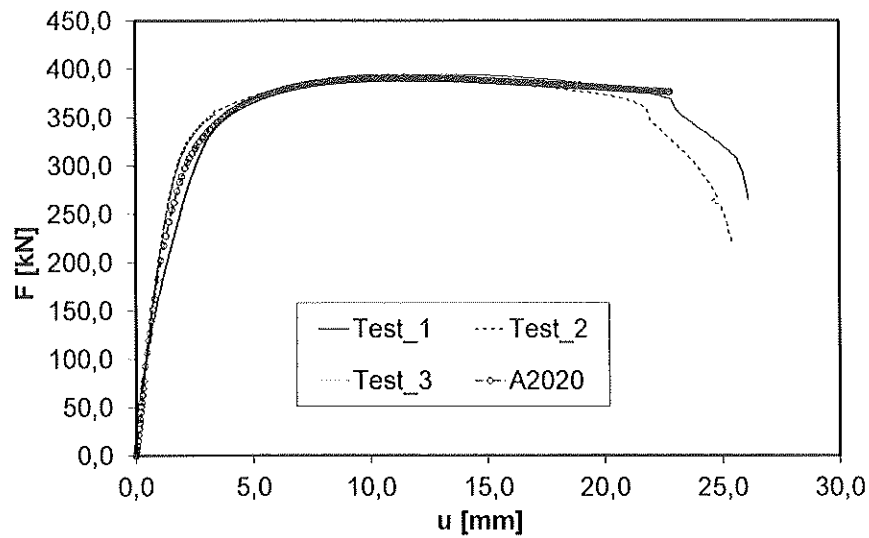

Figure 8 – Simulation of A2020 specimen [4] and comparison with tests.

As a consequence, the characterization of the plate/bolt in bearing behaviour is based hereafter on the existent knowledge: the elastic stiffness and the nominal resistance are determined using code recommendations (see Table 1), while, for the other parameters (strain-hardening stiffness, ultimate resistance and ultimate deformation), expressions from previous works ([6], [10] and [15]) are used.

$$S_{st,p,b} = \frac{S_{p,b}}{40}$$

(3)

$$R_{u,p,b} = 1.25R_{p,b} \quad (4)$$

$$\delta_{u,p,b} = 11 \frac{R_{p,b}}{S_{p,b}} \quad (5)$$

4.3 Plate in tension

Although present research work focuses on the bolt zone and on its capability to redistribute forces, the deformability of a plate in tension has an important influence on the

distribution of forces amongst the bolts. The stiffness of the plate in tension has therefore also to be predicted; an expression is provided in Table 1.

5. Assembly of the basic components

In this section, the individual basic components are assembled with the objective to derive the available ductility of the equivalent bolt zone components and the ductility required to allow a full redistribution of internal forces in shear bolted connections.

5.1 Available deformation capacity of the equivalent bolt zone component

The deformation available in the equivalent bolt zone component is obtained through the “association” of the two basic components: the bolt in shear and the plate/bolt in bearing. Each basic component is characterized and the deformation capacity evaluated according to the previous sections. Subsequently assembly is done according to their resistance and deformability. The complete behaviour of the equivalent bolt zone component is then obtained.

The derivation of formulae to determine the available deformation capacity of the equivalent component depends on several factors such as: single or double overlap connections, plates with equal or different responses (different thickness, different steel properties), and the relation between the resistances of the individual components. So, many cases may be obtained. Figure 9 exemplifies one of these cases and Table 5 presents a list of expressions for several common cases. A comprehensive list of cases can be found in Henriques [6].

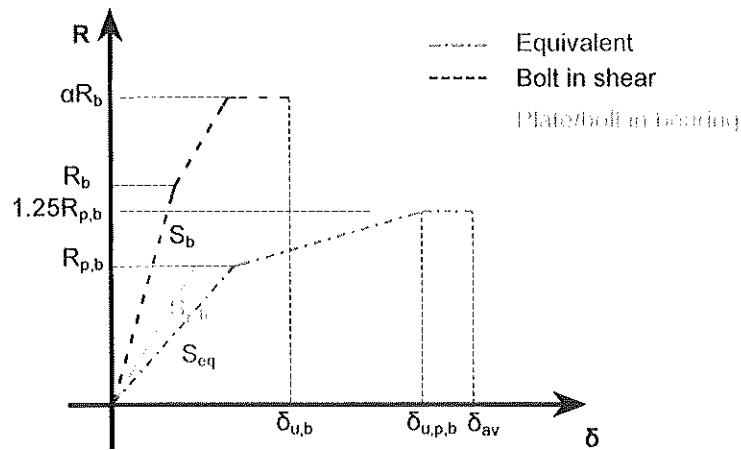

Figure 9 – Assembly of the individual component responses.

Table 5 – Derived expressions to determine the available deformation capacity.

Plates with equal mechanical and geometrical properties	
Single Overlap Connections	Double Overlap Connections
Case: $R_b > 1.25R_{p,b}$	
$\delta_{av} = \frac{R_{eq}}{S_{eq}} + 2 * (\delta_{u,p,b} - \frac{R_{eq}}{S_{p,b}}) + \frac{0.25R_{eq}}{S_b}$	$\delta_{av} = \frac{R_{eq}}{S_{eq}} + (\delta_{u,p,b} - \frac{R_{eq}}{S_{p,b}}) + \frac{0.125R_{eq}}{S_b} + \frac{0.125R_{eq}}{S_{p,b}}$
Case: $R_{p,b} > \alpha R_b$	
$\delta_{av} = \frac{R_{eq}}{S_{eq}} + (\delta_{u,b} - \frac{R_{eq}}{S_b}) + 2 * \frac{(\alpha - 1)R_{eq}}{S_{p,b}}$	$\delta_{av} = \frac{R_{eq}}{S_{eq}} + (\delta_{u,b} - \frac{R_{eq}/2}{S_b}) + \frac{(\alpha - 1)R_{eq}}{S_{p,b}} + \frac{(\alpha - 1)R_{eq}/2}{S_{p,b}}$
Case: $1 \leq R_b/R_{p,b} \leq 1.25$	
$\delta_{av} = \frac{R_{eq}}{S_{eq}} + 2 * (\delta_{u,p,b} - \frac{R_{eq}}{S_{p,b}}) + \frac{R_{eq} - R_{eq}}{S_b} + \frac{(1.25R_{eq} - R_{eq})}{S_b/\beta}$	$\delta_{av} = \frac{R_{eq}}{S_{eq}} + (\delta_{u,p,b} - \frac{R_{eq}}{S_{p,b}}) + \frac{0.125R_{eq}}{S_{p,b}} + \frac{R_{eq} - 0.5R_{eq}}{S_b} + \frac{(0.625R_{eq} - R_{eq})}{S_b/B}$
Case: $1 \leq R_{p,b}/R_b \leq \alpha$	
$\delta_{av} = \frac{R_{eq}}{S_{eq}} + (\delta_{u,b} - \frac{R_{eq}}{S_b}) + 2 * \frac{R_{p,b} - R_{eq}}{S_{p,b}} + 2 * \frac{(1.25R_{eq} - R_{p,b})}{S_{p,b}/40}$	$\delta_{av} = \frac{R_{eq}}{S_{eq}} + (\delta_{u,b} - \frac{R_{eq}/2}{S_b}) + \frac{R_{p,b} - 2R_{eq}}{S_{p,b}} + \frac{(2\alpha R_{eq} - R_{p,b})}{S_{p,b}/40} + \frac{\alpha * R_{eq}/2}{S_{p,b}}$

5.2 Required deformation capacity in actual shear bolted connections

The required deformation capacity is the deformation which should be reached in the most loaded bolt zone in order to get a full plastic redistribution of forces in the connection. In the work done by Pietrapertosa *et al.* [15] expressions to determine the required deformation of the equivalent bolt zone component for fitted bolts have been proposed. Based on that study, similar expressions for actual connections, taking into account the presence of imperfections, are here proposed. The derived expressions should consider the most demanding situation that has been assumed before; i.e. the case where one of the extreme bolts is in contact while the others are not. Several cases have been analysed and it has been concluded that the most demanding case is obtained when the middle bolt zone (or middle bolt zones in the case of even number of bolt rows) is (are) the last one(s) to reach its (their) maximum resistance. Figure 10 shows the deformed shape and the distribution of internal forces for a connection with 5 bolt rows.

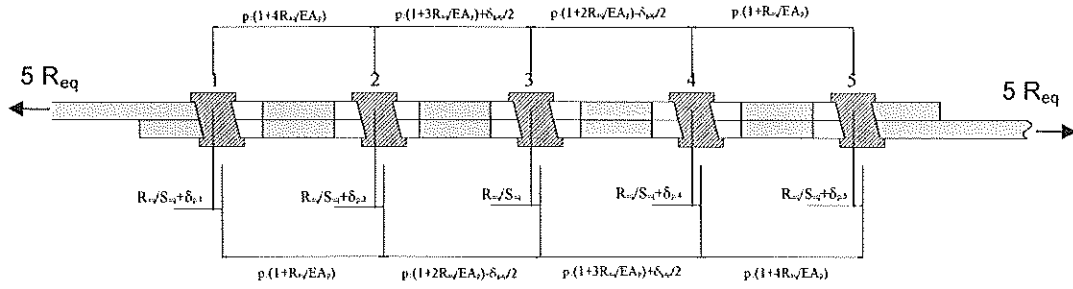

Figure 10 – Connection with 5 bolt rows.

Expressing the compatibility of displacements, the following equations are found:

$$\begin{aligned}
 (a) \quad & p_1 \left(1 + \frac{4R_{eq}}{EA_p} \right) + \frac{R_{eq}}{S_{eq}} + \delta_{p,2} = p_1 \left(1 + \frac{R_{eq}}{EA_p} \right) + \frac{R_{eq}}{S_{eq}} + \delta_{p,1} \\
 (b) \quad & p_1 \left(1 + \frac{3R_{eq}}{EA_p} \right) + \frac{R_{eq}}{S_{eq}} = p_1 \left(1 + \frac{2R_{eq}}{EA_p} \right) + \frac{R_{eq}}{S_{eq}} + \delta_{p,2} \\
 (c) \quad & p_1 \left(1 + \frac{2R_{eq}}{EA_p} \right) + \frac{R_{eq}}{S_{eq}} + \delta_{p,4} = p_1 \left(1 + \frac{3R_{eq}}{EA_p} \right) + \frac{R_{eq}}{S_{eq}} \\
 (d) \quad & p_1 \left(1 + \frac{R_{eq}}{EA_p} \right) - \frac{\delta_{gap}}{2} + \frac{R_{eq}}{S_{eq}} + \delta_{p,5} = p_1 \left(1 + \frac{4R_{eq}}{EA_p} \right) + \frac{\delta_{gap}}{2} + \frac{R_{eq}}{S_{eq}} + \delta_{p,4}
 \end{aligned} \tag{6}$$

Solving the system of equations, the plastic deformation in bolt zone 1, 2, 3 and 4 is determined:

$$\begin{aligned}
(a) \delta_{p,1} &= \frac{4R_{eq}}{EA_p} p_1 \\
(b) \delta_{p,2} &= \frac{R_{eq}}{EA_p} p_1 \\
(c) \delta_{p,3} &= \frac{R_{eq}}{EA_p} p_1 \\
(d) \delta_{p,5} &= \delta_{gap} + \frac{4R_{eq}}{EA_p} p_1
\end{aligned} \tag{7}$$

Finally, the required deformation for the equivalent bolt zone component is obtained:

$$\delta_{req} = \frac{R_{eq}}{S_{eq}} + \delta_{gap} + \frac{4R_{eq}}{EA_p} \tag{8}$$

This analysis has been extended to other cases (different number of bolt rows) and the following general expression has been obtained:

$$\delta_{req} = R_{eq} \left(\frac{1}{S_{eq}} + \rho \frac{p_1}{EA_p} \right) + \delta_{gap}$$

with

$$\rho = \sum_{i=1}^{n_1/2} (n_1 - 2i) \text{ for an even value of } n$$

$$\rho = \sum_{i=1}^{(n_1-1)/2} (n_1 - 2i) \text{ for an odd value of } n$$
(9)

At the same time, a numerical model, based on the use of the Liège home-made nonlinear FEM software FINELG [3], allowed validating all the analytical results. The numerical model is based on the simplified model presented in Figure 3c. This simple model avoids the contact problems, which are always difficult to manage; the numerical model is then defined by modelling the plate in tension behaviour through the use of beam elements and the bolt zone by means of springs. Using the numerical model, analytical expressions and numerical results are compared: in Figure 11, the required deformation capacity to the bolt zone component calculated through expression (8) and the numerical model, for a connection with 5 bolt rows; in Figure 12, the plastic deformation achieved by each bolt zone when the last one reaches R_{eq} by means of expressions (7), again for a case with 5 bolt rows.

The different cases analysed correspond to the different values of defined gap. The values considered for the gap varies proportionally to the conventional limit of elastic deformation of the equivalent bolt zone component and are the following: $\delta_{gap} = \delta_{el}$ (case 1); $\delta_{gap} = 1.1 * \delta_{el}$ (case 2); $\delta_{gap} = 1.2 * \delta_{el}$ (case 3); $\delta_{gap} = 1.3 * \delta_{el}$ (case 4). In Figure 12, only case 1 is represented as the results for the other cases are the same.

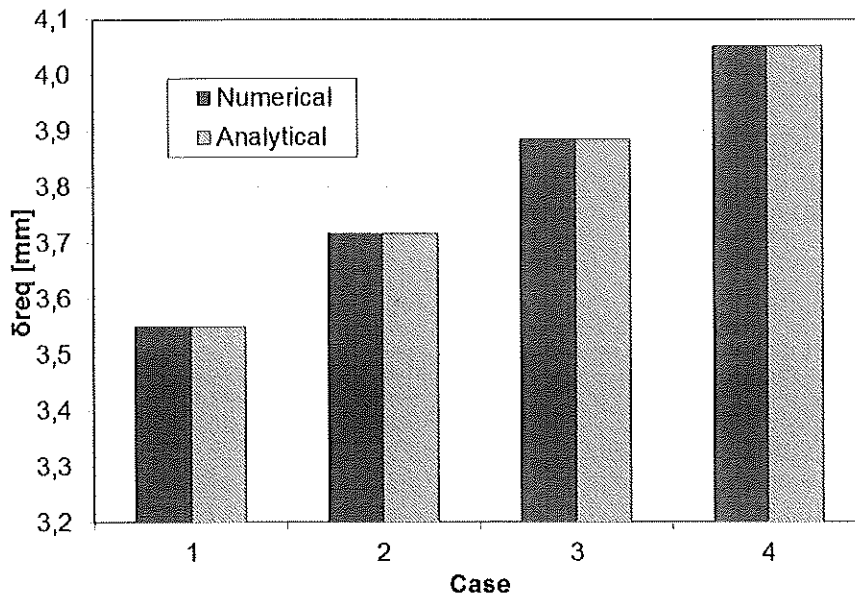

Figure 11 – Comparison of required deformation between numerical model and formulae.

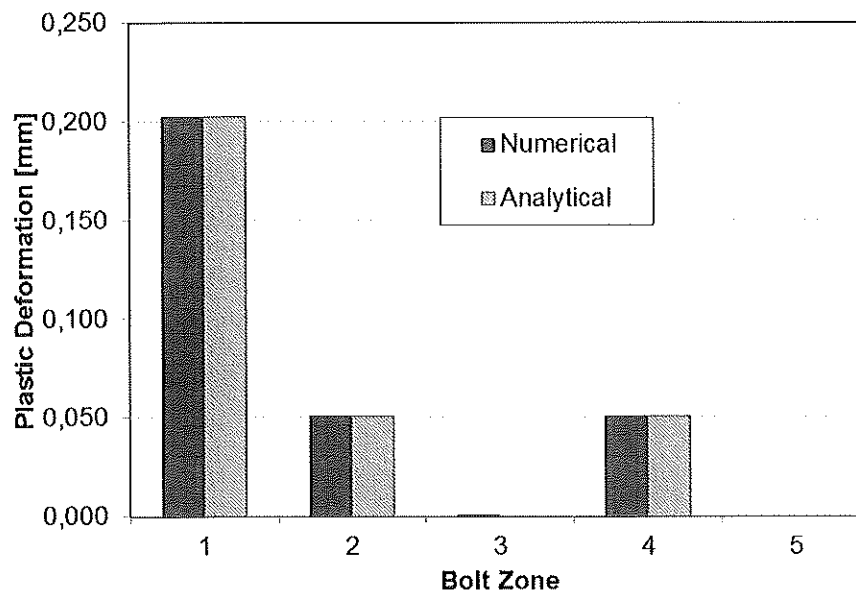

Figure 12 – Comparison of plastic deformation between numerical model and formulae (case 1).

6. Ductility requirements for bolted shear connections

In order to determine ductility requirements that a connection should satisfy so as to ensure a full plastic redistribution of the internal forces amongst the bolt zones, reference will obviously be made to the expressions derived before for the available and required ductility in bolt zone components; hence, such ductility requirements are for sure dependent on all the geometrical and mechanical parameters that influence the two previously mentioned values of ductility:

- Steel grade of the plate;
- Bolt grade;
- Geometrical properties of the connection [t , b , e_1 , e_2 , p_1 , p_2 , d , d_0];
- Number of bolt rows (n_1 – in the direction of loading) and number of bolt lines (n_2 – in the perpendicular direction of loading).

The ductility criterion which is expressed below and which constitutes the main outcome of the study is based on an intensive parametrical study where all the above-listed geometrical and mechanical parameters have been considered, but for single overlap connections only (what is not really restrictive). As mentioned before, situations where tension plate failure is relevant have been omitted.

The problem is dependent on many basic parameters (listed above). Therefore, fundamental parameters which embody all these and simplify the task by avoiding multiple sub-criteria have been defined. Two fundamental parameters have been defined in view of the derivation of a ductility criterion, as illustrated in Figure 13.

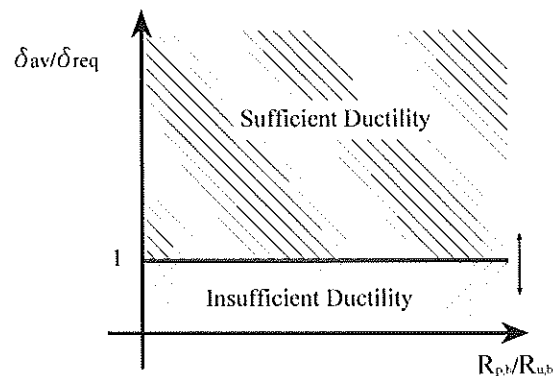

Figure 13 – Two fundamental parameters.

The parameter on the vertical axis represents the ratio between the available and the required deformation capacities. This ratio reflects the sufficient or insufficient ductility exhibited by the equivalent bolt zone component. The second fundamental parameter represents the ratio between the nominal resistance of the plate/bolt in bearing component and the ultimate resistance of the bolt in shear component. These two parameters embody all the important mechanical and geometrical parameters listed before.

This being, the influence of each basic parameter was analyzed and “ductility functions” were obtained. Figure 14 presents the results of the parametrical analysis in which the following variation of the basic parameters have been considered:

- Steel grade: S235 and S355;
- Bolt diameters: M16, M20 and M24;
- Spacing, end and edge distances: max and min of e_1 , e_2 , p_1 and p_2 ;
- Width of the plates: max and min values e_2 and p_2 as well as max and min values of b taken into account;
- Thickness of the plate: the variation of t is made in order to cover the whole ranges of $R_{p,b}/R_{u,b}$;
- Finally, the number of bolt rows and lines varies: n_1 , from 2 to 10, and n_2 , from 1 to 5.

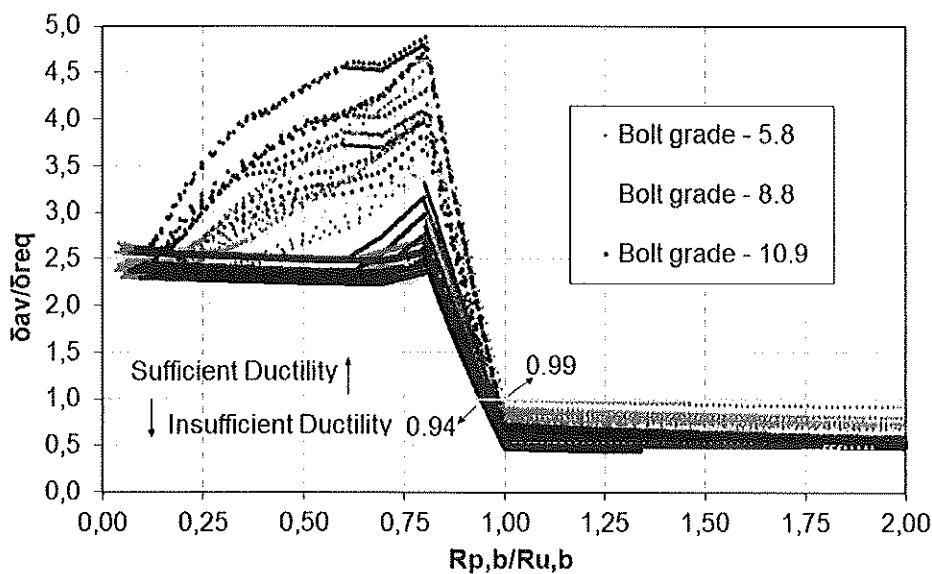

Figure 14 – Parametric analysis results.

One can observe that the variation of the fundamental parameter $R_{p,b}/R_{u,b}$, close to the boundary between sufficient and insufficient ductility ($\delta_{av}/\delta_{req}=1$) is small, from 0.94 to 0.99. So, a safe and simplified ductility criterion may be suggested as follows:

$$\left\{ \begin{array}{l} \text{If } \frac{R_{p,b}}{R_{u,b}} \leq 0.94 \Rightarrow F_{r,c} = n_1 n_2 R_{eq} \text{ (plastic distribution of internal forces allowed)} \\ \text{If } \frac{R_{p,b}}{R_{u,b}} > 0.94 \Rightarrow F_{r,c} < n_1 n_2 R_{eq} \text{ (plastic distribution of internal forces not allowed)} \end{array} \right. \quad (10)$$

Figure 14 clearly identifies the plate/bolt in bearing as ductile component and the bolt in shear as a brittle one. When the plate/bolt bearing is the strongest component and its contribution to the deformation of the equivalent component is small, insufficient ductility is exhibited by the equivalent bolt zone component to reach a complete plastic redistribution in the connection.

In order to apply the criterion, some practical cases have been considered and the results have been compared with the present Eurocode 3 rules. This comparison considered two situations, one where the criterion is verified and another where it is not. The obtained results are presented in Figure 15. In the horizontal axis is represented the length of the joint, according to the code, and in the vertical axis the reduction factor β_{LF} for long joints. The analysed cases consider the variation of the connection length by varying the number of bolt rows (number of bolts along load direction). All the other properties were kept constant. The number of lines of bolts is 2 (number of bolts over the transversal direction of the applied load).

The results confirm that if the condition expressed in (10) is verified, the available ductility is sufficient to achieve a full plastic resistance of the connection even in joints that exceed the limit imposed by the code. One can also observe that, in the case of a low contribution by the plate/bolt in bearing component to the deformation of the equivalent one, the available ductility is clearly insufficient and the maximum load the connection is able to transfer is considerably reduced.

The comparison with Eurocode 3 criterion shows a significant difference. The code establishes as main condition the length of the joint while the proposed criterion is based in the

contribution of the basic components to the available deformation of the equivalent bolt zone component. For cases where ratio $R_{p,b}/R_{u,b}$ is smaller than 0.94 (high contribution of the plate/bolt in bearing) the code approach is conservative while for higher values of this ratio the code is on the unsafe side.

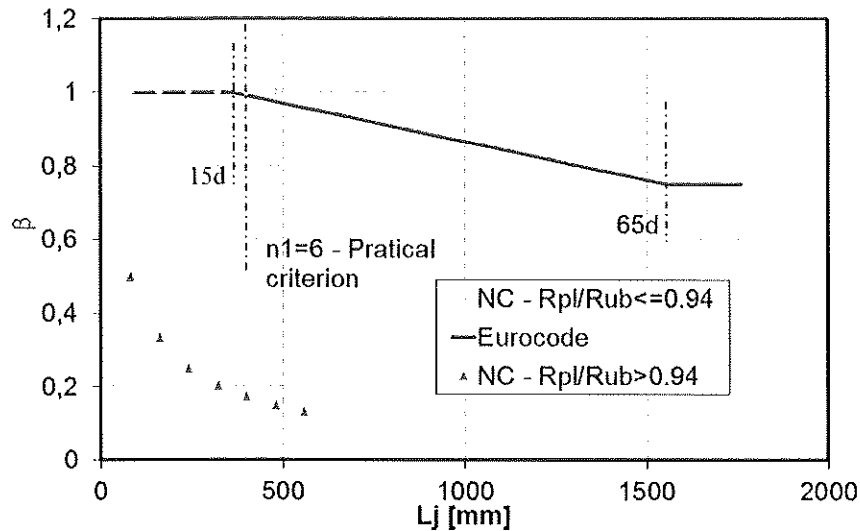

Figure 15 – Comparison with the Eurocode 3 criterion.

7. Conclusions

The present work proposes a criterion to check whether sufficient ductility for a full plastic redistribution of internal forces may be contemplated in actual shear connections with non preloaded bolts. It is based on the presence of imperfections in the connection layout which can lead to situations where some bolts bear before the others.

All the aspects inherent to shear bolted connections have been approached: the evaluation of imperfections according to the standards for tolerances; the characterization of the individual component response; the derivation of expressions to determine the available deformation capacity in the bolt zone component; the required deformation in the bolt zone component for a full plastic redistribution of forces.

From the analysis of several layouts it has been verified that imperfections should be applied in order to minimize the gap in one of the external bolt zone which starts transferring load first and maximize the gap in all the others. The values proposed vary according to the bolt diameter; however the general configuration of the connection is the same. These values define

extreme situations that can be observed in a connection layout obeying to the standards recommendations for tolerances.

Empirical functions to characterize the behaviour of bolts in shear have been proposed. These functions confirmed that ductility decreases with the increase of the bolt grade. Tri-linear laws have been proposed using Eurocode design functions. The ultimate deformation of bolts in shear is evaluated using these design functions; thus, a lack in the code could be filled and the deformation capacity of the bolt in shear estimated.

The expressions proposed to determine the available deformation capacity of the equivalent component, show that the available deformation depends on the level of contribution of the two components. The application of these expressions shows the expected results: high deformation is available if the plate/bolt in bearing has high contribution to the global deformation while the opposite is observed if the bolt in shear is the leading basic component. The presented expressions include a limited group of situations considered as the most usual ones. Based on these, any other situation can be derived.

In the work of Pietrapertosa *et al.* (2004) [15] the evaluation of required deformation capacity in shear bolted connections with fitted bolts has been done. Using the same principles, this evaluation has been extended to actual shear bolted connections and the effect of imperfections introduced. Higher deformation capacity is obviously required. The obtained expression is similar to the one presented by the referred authors; the modification consists in the addition of the gap presented by the last bolt zone to reach its yield strength R_{eq} .

Through the evaluation of the available and required deformation capacity in the equivalent bolt zone component a ductility criterion has been derived. The proposed criterion, equation (10), is simplified by the use of two fundamental parameters which involve all basic ones that need to be taken into account. One considers the sufficient or insufficient deformation capacity presented by the equivalent component $\left(\frac{\delta_{av}}{\delta_{req}}\right)$, while the other takes into account the participation of each basic component in the global deformation of the equivalent bolt zone component $\left(\frac{R_{p,b}}{R_{u,b}}\right)$.

The application of the proposed criterion showed considerable differences between the code criterion and the proposed one. This fact shows that imperfections may have a relevant

effect in the connection behaviour if the bolt in shear component is the "weakest". Actually, in these cases the transferred force is considerably smaller than the one determined according to the code provisions, as observed in Figure 15. This situation should then be further investigated in future works. At the same time the evaluation of the imperfections in the connection layout should be better analysed. The values here obtained (based on the "worst" layout of imperfections) seem to be too severe for the case of "weak" bolts, as seen in Figure 15.

Acknowledgments

For sharing their experimental data, the authors would like to express their thanks to Delft University of Technology in the name of Prof. F. S. K. Bijlaard and to University of Ljubljana in the name of Prof. Darko Beg. Concerning the use of LAGAMINE code, a word of gratitude should be said to the "LAGAMINE Group" of ArGEnCo Department of the University of Liège. Finally, Mr. Piraprez is acknowledged for sharing his knowledge and documents.

References

- [1] CEN, European Committee for Standardization (2005) – "Eurocode 3: Design of steel structures – Part 1-8: Design of joints", Final Draft prEN 1993-1-8, December 2003, Brussels, Belgium.
- [2] CEN, European Committee for Standardization (2008) – "Execution of steel structures and aluminium structures – Part 2: Technical requirements for the execution of steel structures –EN 1090-2, July 2008, Brussels, Belgium.
- [3] FineLg User's manual, V9.0 (2004) – University of Liège (M&S) / Design office Greisch, Belgium.
- [4] Freitas, S. T. (2005) – "Experimental research project on bolted connections in bearing for high strength steel", Final report of the framework of the Socrates-Erasmus program, June 2005.
- [5] Greisnigt, A.M.; Steenhuis, C.M. (2000) - "Stiffness of lap joints with preloaded bolts", in L. Baniotopoulos and F. Wald (eds.), *The paramount role of joints into the reliable response of structures*, NATO ASI Series, Kluwer Academic Publishers, pp. 435-448, 2000.
- [6] Henriques, J. (2008) – "Ductility requirements in shear bolted connections", Master Thesis, Coimbra, Portugal, January 21.

- [7] ISO (1999) – “Tolérances des éléments de fixation – Partie 1: Vis, goujons et écrous – Grades A, B et C”, Projet de Norme Internationale, ISO/DIS 4759-1.2.
- [8] ISO (2006) – “Système ISO de tolérance et d’ajustements – Partie 2: Tables des degrés de tolérance normalisés et écarts limites des alésages et des arbres” – Norme Base”, ISO 286/DIN 267 – 2.
- [9] Ju, S.-H.; Fan, C.-Y.; Wu, G. H. (2003) – “Three-dimensional finite elements of steel bolted connections”, *Engineering Structures* 26, 2004, 403-413.
- [10] Jaspard, J.-P. (1991) – “Etude de la semi-rigidité des nœuds poutre-colonne et son influence sur la résistance et la stabilité des ossatures en acier”, Ph. D. Thesis, M&S Departement, Liège University, Belgium.
- [11] Jaspard, J.-P. ; Demonceau, J.-F. (2008) – “European design recommendations for simple joints in steel structures”, *Journal of Constructional Steel Research* 64, January 18, 2008, pp. 822 – 832.
- [12] Karmalin, V. V. and Pavlov A. B. (1989) – “Load capacity and deformability of bearing and friction-bearing connections”, *Proceedings of the International Colloquium on Bolted and Special Structural Connections*, USSR, Moscow, May 15-20, pp. 52-60.
- [13] LAGAMINE code, Finite Element Software, ArGEnCO Department, Liège University, Belgium.
- [14] Moze, P.; Beg, D.; Lopatic, J. (2006) – “Ductility and Strength of bolted connections made of high strength steel”, *International conference in metal structures “Steel – A new and traditional material for buildings”*, Poiana Brasov, Romania, September 20-22, pp. 323-330.
- [15] Pietrapertosa C.; Piraprez E.; Jaspard J.P. (2004) – “Ductility requirements in shear bolted connections”, *ECCS/AISC Workshop: Connections in steel structures V: Behaviour, Strength and Design*, Amsterdam, The Netherlands, June 3-4, pp. 335-345.
- [16] Wald, F.; Sokol, Z.; Moal, M.; Mazura, V.; Muzeau, J. P. (2002) – “Stiffness of cover plate connections with slotted holes”, *Eurosteel: Third European conference on Steel Structures*, Coimbra, Portugal, pp. 1007-1016.
- [17] Weynand, k.; Jaspard, J.P. and Steenhuis, M. (1995) – “The stiffness model of revised annex J of Eurocode 3”, *Proceedings of 3rd International Workshop on Connections*, Trento, Italy, May 8-31, pp. 441-452, 1995.