

Cours interuniversitaire  
Néphrologie  
Les Syndromes Cardio-rénaux

JM KRZESINSKI  
ULg-CHU Liège  
16 février 2013

# Lien entre cœur et rein

- 30% des patients hospitalisés en cardiologie pour décompensation cardiaque ont une insuffisance rénale. Ceci va influencer la prise en charge.
- Le patient insuffisant rénal a 20X plus de risque de décéder d'un problème cardiovasculaire que d'aller en dialyse!
- Le patient avec une IRA est candidat pour développer une IRC.

# Syndrome cardiorenal (CRS)

- Type I:
  - Décompensation cardiaque aigue menant à une insuffisance rénale aigue
- Type II:
  - Anomalie chronique de la fonction cardiaque causant une insuffisance rénale chronique
- Type III:
  - Insuffisance rénale aigue entraînant une dysfonction cardiaque aigue
- Type IV:
  - Insuffisance rénale chronique causant une atteinte cardiaque
- Type V:
  - Condition systémique causant une atteinte des 2 organes

## Définition de l'Insuffisance cardiaque

- Basée sur la clinique (dyspnée classée NYHA I-IV)
- Basée sur l'échocardiogramme (dysfonction systolique FEVG<45% ou diastolique FEVG>45% avec doppler tissulaire E/A<0.8)
- Basée sur la biologie (BNP- NT-proBNP)

## Définition de l'Insuffisance rénale aiguë

**AKI is defined as any of the following (*Not Graded*):**

- **Increase in SCr by  $>0.3$  mg/dl within 48 hours; or**
- **Increase in SCr by  $>1.5$ -fold above baseline, which is known or presumed to have occurred within 7 days; or**
- **Urine volume  $<0.5$  ml/kg/h for 6 hours.**

# Définition Insuffisance Rénale Chronique

## 1.1 Definition of CKD

**1.1.1:** CKD is defined as *abnormalities of kidney structure or function, present for  $\geq 3$  months, with implications for health (see below). (Not Graded)*

### **Criteria for CKD (either of the following present for $\geq 3$ months)**

<b>Markers of Kidney Damage</b>	Albuminuria $> 30$ mg/day
	Urine sediment abnormalities (e.g., hematuria, red cell casts etc)
	Electrolyte and other abnormalities due to tubular disorders
	Abnormalities detected by histology
	Structural abnormalities detected by imaging
	History of kidney transplantation
<b>Decreased GFR</b>	GFR $< 60$ mL/min/1.73 m <sup>2</sup>

# Pour définir une Insuffisance Rénale, on n'utilise pas le dosage de l'urée

- L'urée augmentera si déshydratation, diurétique, saignement digestif, catabolisme >
- L'urée s'abaissera si pathologie hépatique, surcharge en eau, carence protéinée
- Ce n'est donc pas un bon marqueur de la présence d'Insuffisance Rénale
- Mais c'est un marqueur du risque de décès si CHF!!! (étude OPTIME)

# CRS Type 1

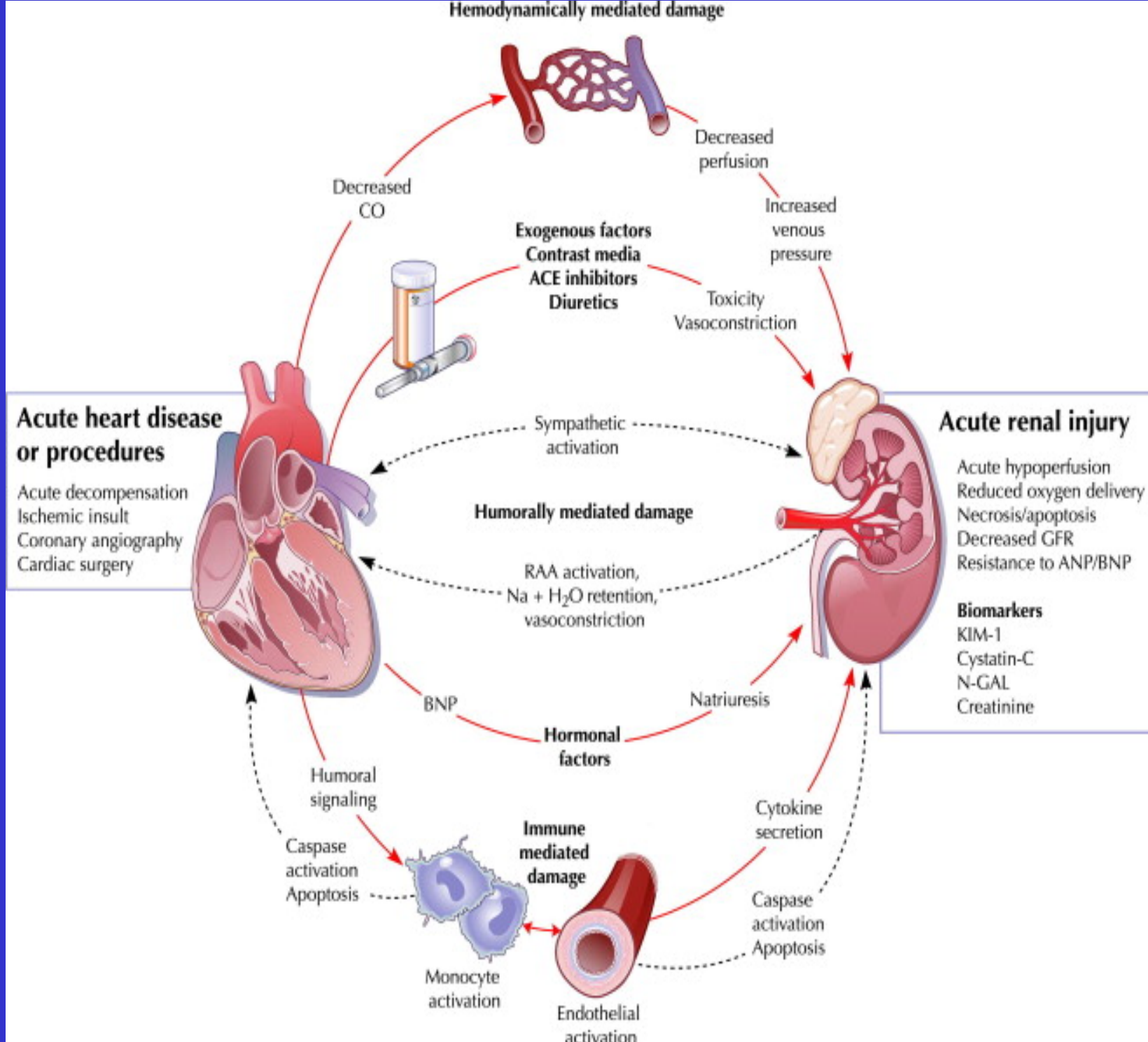



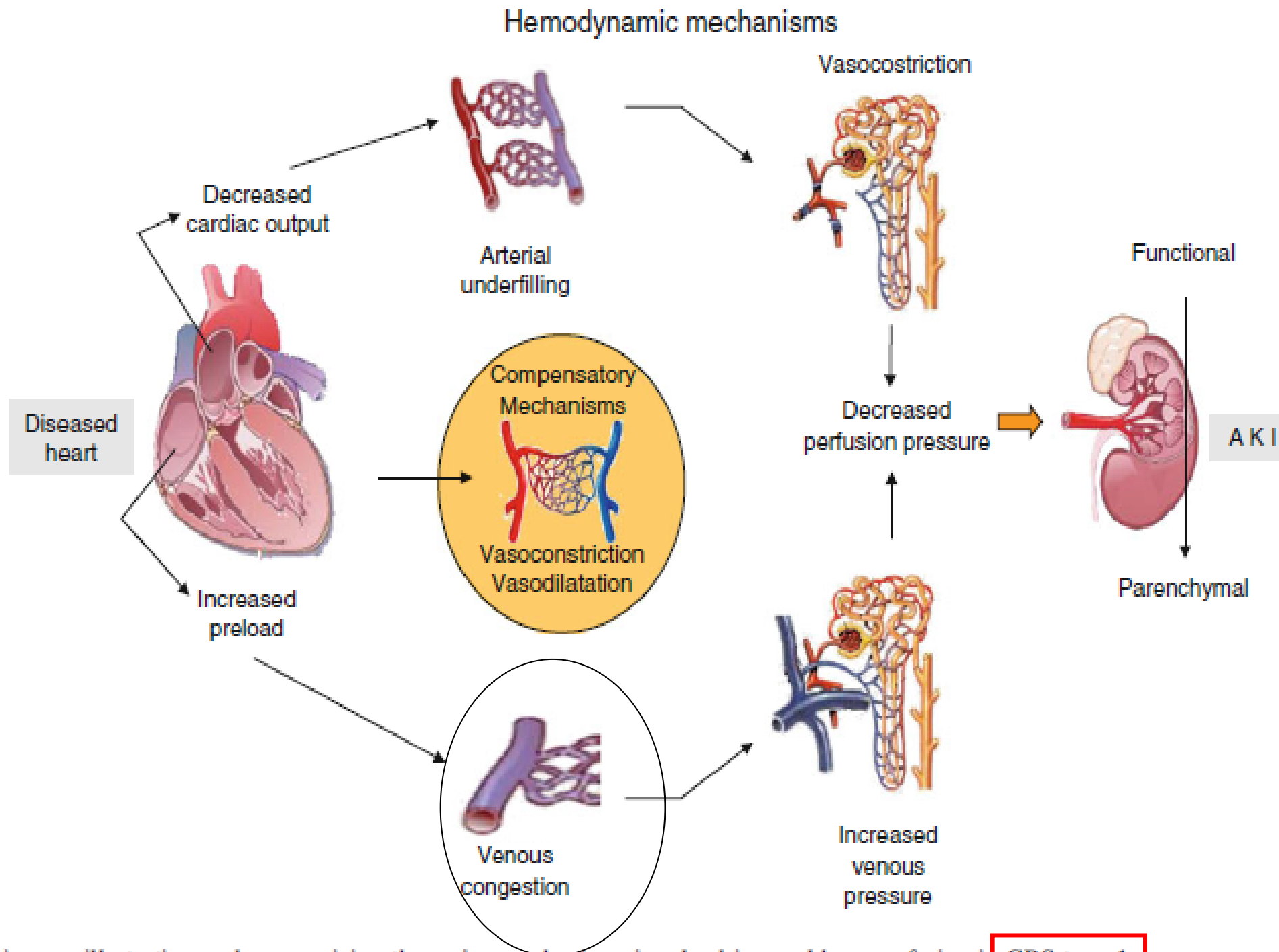

Fig. 2 Diagram illustrating and summarizing the major mechanisms involved in renal hypoperfusion in CRS type 1

# Acute Cardio-renal Syndrome

- 1. Low renal perfusion and high renal congestion inducing AKI
- 2. It may decrease diuretic responsiveness
- 3. May need extra-renal UF
- 4. AKI can modify the treatment (RAS blocker avoidance and diuretic type and dose)
- 5. High mortality

# Principaux traitements dans le syndrome CR de type 1.

1. Oxygénation nasale ou par VNI
2. Clinostatisme et régime hyposodé et limiter les boissons
3. Nitrés IV si la pression artérielle systolique est  $> 100$  mmHg
4. Arrêt des bloqueurs du SRA, si PAS  $< 100$  mmHg
4. Diurétique de l'anse IV (perfusion ou bolus)
5. Recours à l'UF EC si résistance aux diurétiques de l'anse
6. De peu d'intérêt: nésiritide, vaptans, antagonistes de l'endothéline et de l'adénosine, les inotropes

Exploration par PCI exposant à un risque majeur de dialyse

VNI : ventilation non invasive , UF: ultrafiltration, IV: intraveineux,  
EC: extracorporelle

# *Les Diurétiques*

## *Données pharmacocinétiques*

- forte liaison à l'albumine
- sécrétion par le tube proximal (voie des ac.organiques faibles)
- atteignent leur site d'action via le fluide tubulaire (sauf la spironolactone)

D'où moins efficaces si Insuffisance Rénale

# Décompensation cardiaque (DC) sévère (en dehors de l'OAP)

- **Diurétique de l'anse** administré plusieurs fois par jour ou en perfusion (lutter contre la rétention sodée en fin de dose).
- Etude ESCAPE (2007): la dose de Diurétique quand DC hospitalisée est proportionnelle à la mortalité
- **Si réfractaire, ajouter:**
  - si GFR > 50 ml/min, spironolactone
  - si GFR < 50 ml/min, thiazide

# Diurèse selon la dose de furosémide à l'admission et l'administration en bolus ou en perfusion continue

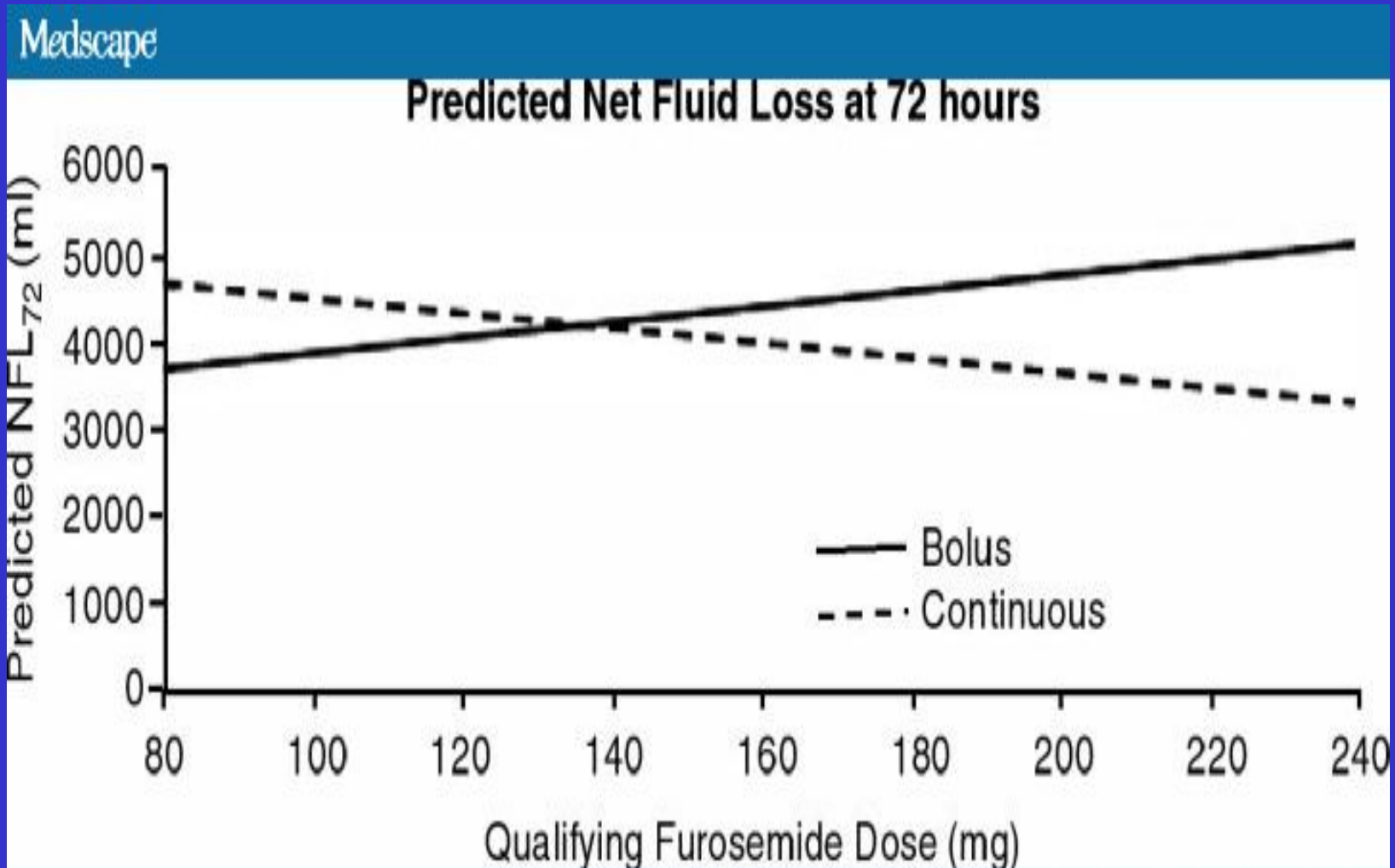

# Acute Cardio-renal Syndrome

- 1. It leads to a High mortality
- 2. It may decrease diuretic responsiveness
- 3. May exacerbate CHF
- 4. May need extra-renal UF  
(ex: Aquadex Flex Flow)



## Ultrafiltration Versus Intravenous Diuretics for Patients Hospitalized for Acute Decompensated Heart Failure

Maria Rosa Costanzo, MD, FACC,\* Maya E. Guglin, MD, FACC,†  
 Mitchell T. Saltzberg, MD, FACC,\* Mariell L. Jessup, MD, FACC,‡ Bradley A. Bart, MD, FACC,§  
 John R. Teerlink, MD, FACC,|| Brian E. Jaski, MD, FACC,¶ James C. Fang, MD, FACC,#  
 Erika D. Feller, MD, FACC,\*\* Garrie J. Haas, MD, FACC,†† Allen S. Anderson, MD, FACC,‡‡  
 Michael P. Schollmeyer, DVM,§§ Paul A. Sobotka, MD, FACC,§§ for the UNLOAD Trial Investigators

**Methods** Patients hospitalized for HF with  $\geq 2$  signs of hypervolemia were randomized to ultrafiltration or intravenous diuretics. Primary end points were weight loss and dyspnea assessment at 48 h after randomization. Secondary end points included net fluid loss at 48 h, functional capacity, HF rehospitalizations, and unscheduled visits in 90 days. Safety end points included changes in renal function, electrolytes, and blood pressure.

**Results** Two hundred patients ( $63 \pm 15$  years, 69% men, 71% ejection fraction  $\leq 40\%$ ) were randomized to ultrafiltration or intravenous diuretics. At 48 h, weight ( $5.0 \pm 3.1$  kg vs.  $3.1 \pm 3.5$  kg;  $p = 0.001$ ) and net fluid loss ( $4.6$  vs.  $3.3$  l;  $p = 0.001$ ) were greater in the ultrafiltration group. Dyspnea scores were similar. At 90 days, the ultrafiltration group had fewer patients rehospitalized for HF (16 of 89 [18%] vs. 28 of 87 [32%];  $p = 0.037$ ), HF rehospitalizations ( $0.22 \pm 0.54$  vs.  $0.46 \pm 0.76$ ;  $p = 0.022$ ), rehospitalization days ( $1.4 \pm 4.2$  vs.  $3.8 \pm 8.5$ ;  $p = 0.022$ ) per patient, and unscheduled visits (14 of 65 [21%] vs. 29 of 66 [44%];  $p = 0.009$ ). No serum creatinine differences occurred between groups. Nine deaths occurred in the ultrafiltration group and 11 in the diuretics group.

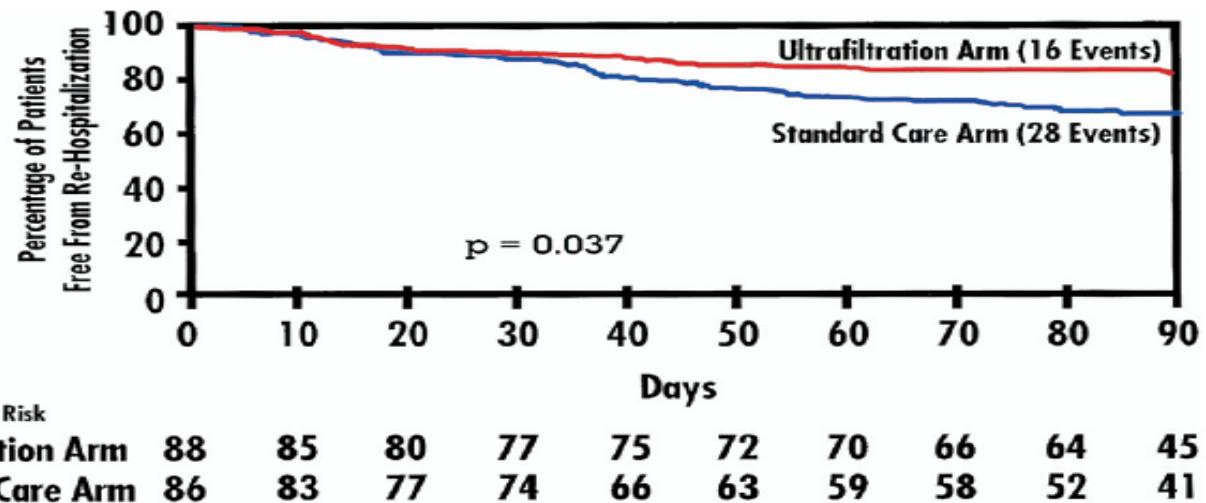
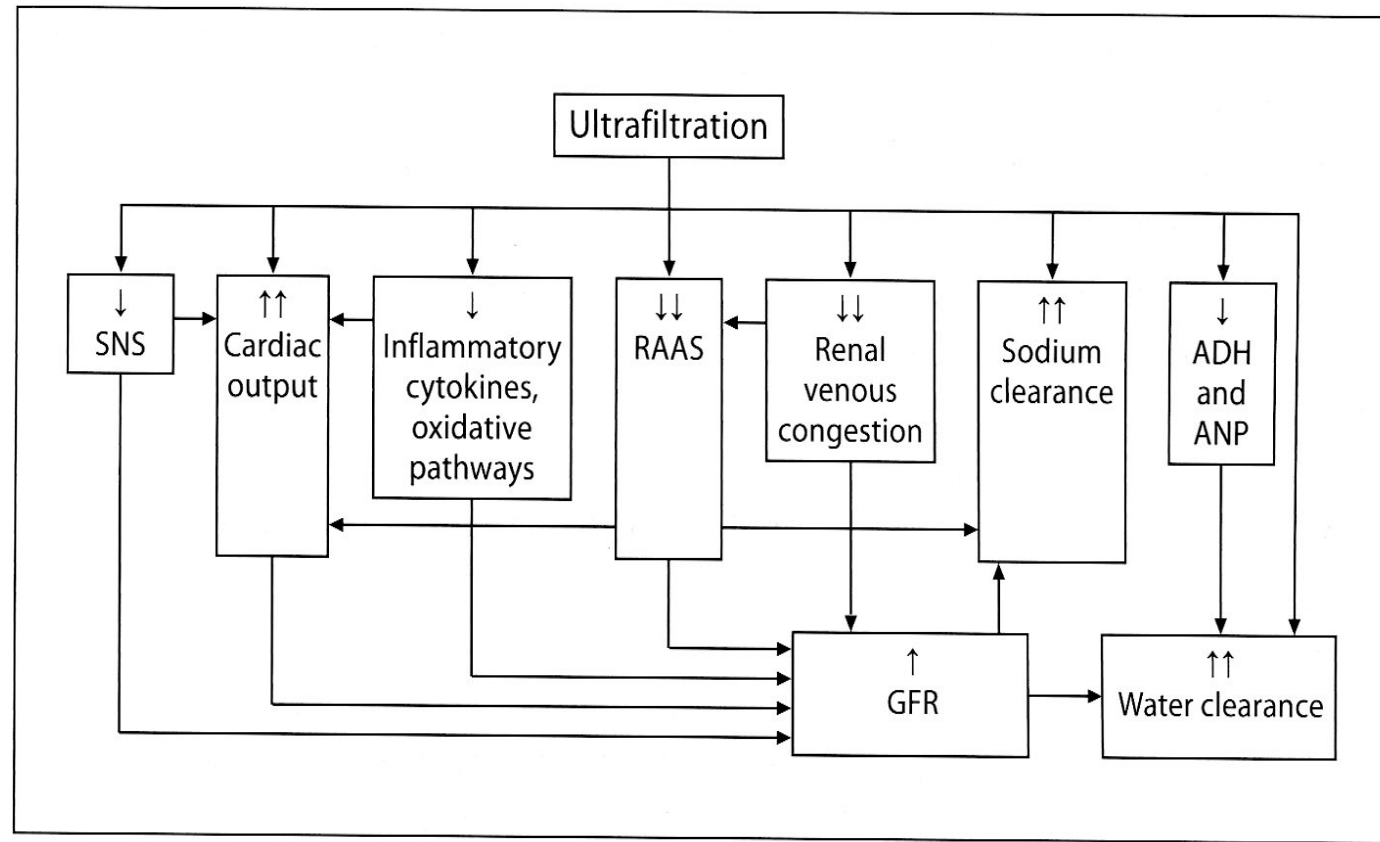

**Figure 2** Freedom From Heart Failure Rehospitalization

Kaplan-Meier estimate of freedom from rehospitalization for heart failure within 90 days after discharge in the ultrafiltration (red line) and standard care (blue line) groups.

In decompensated HF, ultrafiltration safely produces greater weight and fluid loss than intravenous diuretics, reduces 90-day resource utilization for HF, and is an effective alternative therapy. (The UNLOAD trial; <http://clinicaltrials.gov/ct/show/NCT00124137?order=1>; NCT00124137). (J Am Coll Cardiol 2007;49:675-83)

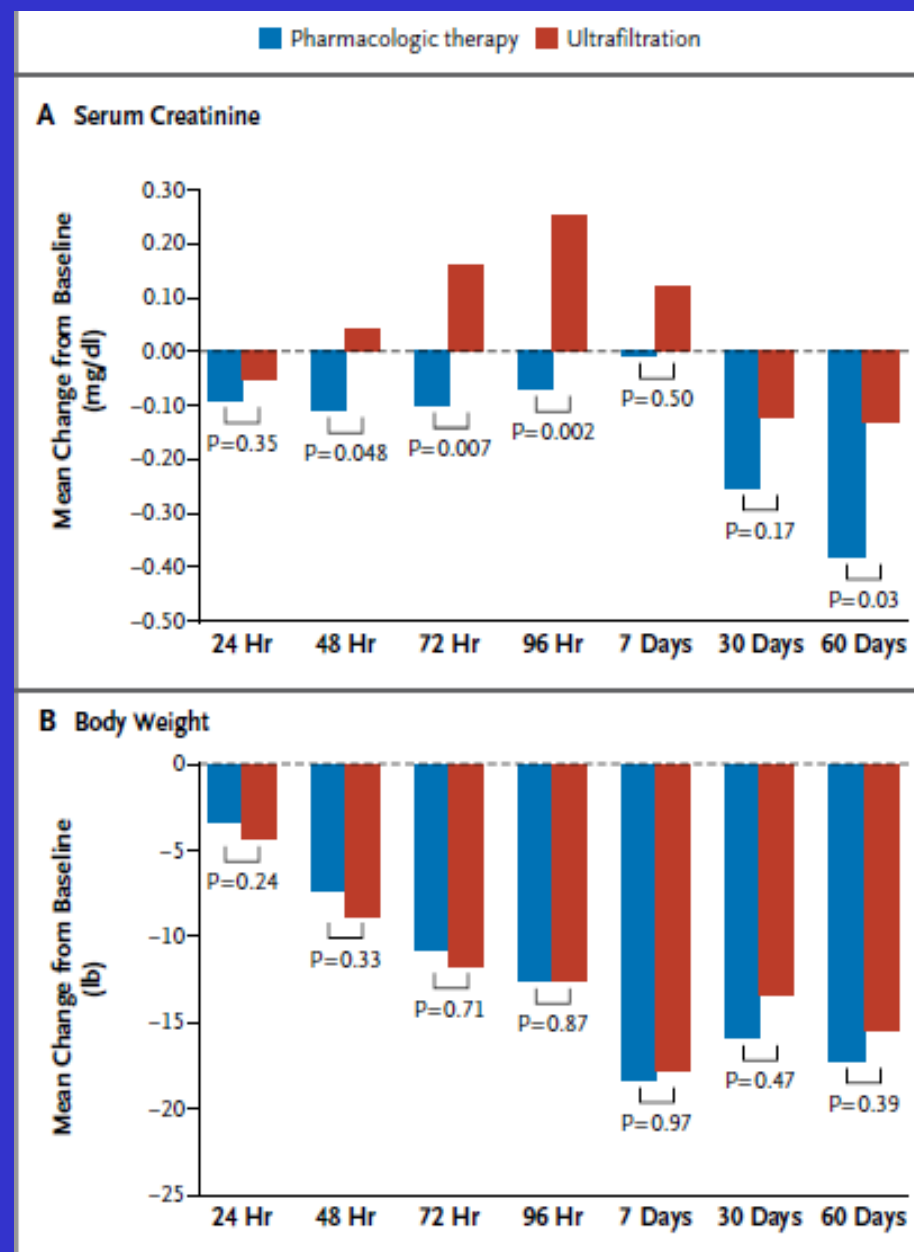



**Fig. 1.** Proposed mechanisms for the impact of UF on renal function and other kidney-related parameters. Double arrows indicate pathways of greater clinical relevance. SNS = Sympathetic nervous system; ADH = antidiuretic hormone; RAAS = renin-angiotensin-aldosterone system; ANP = atrial natriuretic peptide.

# Acute Cardio-renal Syndrome

Etude CARRESS-HF:  
 pas de supériorité  
 par rapport aux  
 diurétiques à 60j  
 avec plus EII à 96h  
 (NEJM Dec 2012)



**Figure 2.** Changes from Baseline in Serum Creatinine and Body Weight at Various Time Points, According to Treatment Group.

## Risk factors for Radio-Contrast Agent-induced AKI

- High RF: CKD, Diabetes mellitus, CHF
- Moderate RF: Dehydration, treatment by NSAIDs, ACEI, Sartans, Anemia, volume of injected CM
- Low RF: MM, advanced age
  
- Utiliser la plus faible dose de PCI, isosmotique si possible, arrêter les diurétiques la veille et laisser boire avant ou perfuser si IR stade >3

## ACUTE HEART-KIDNEY INTERACTIONS

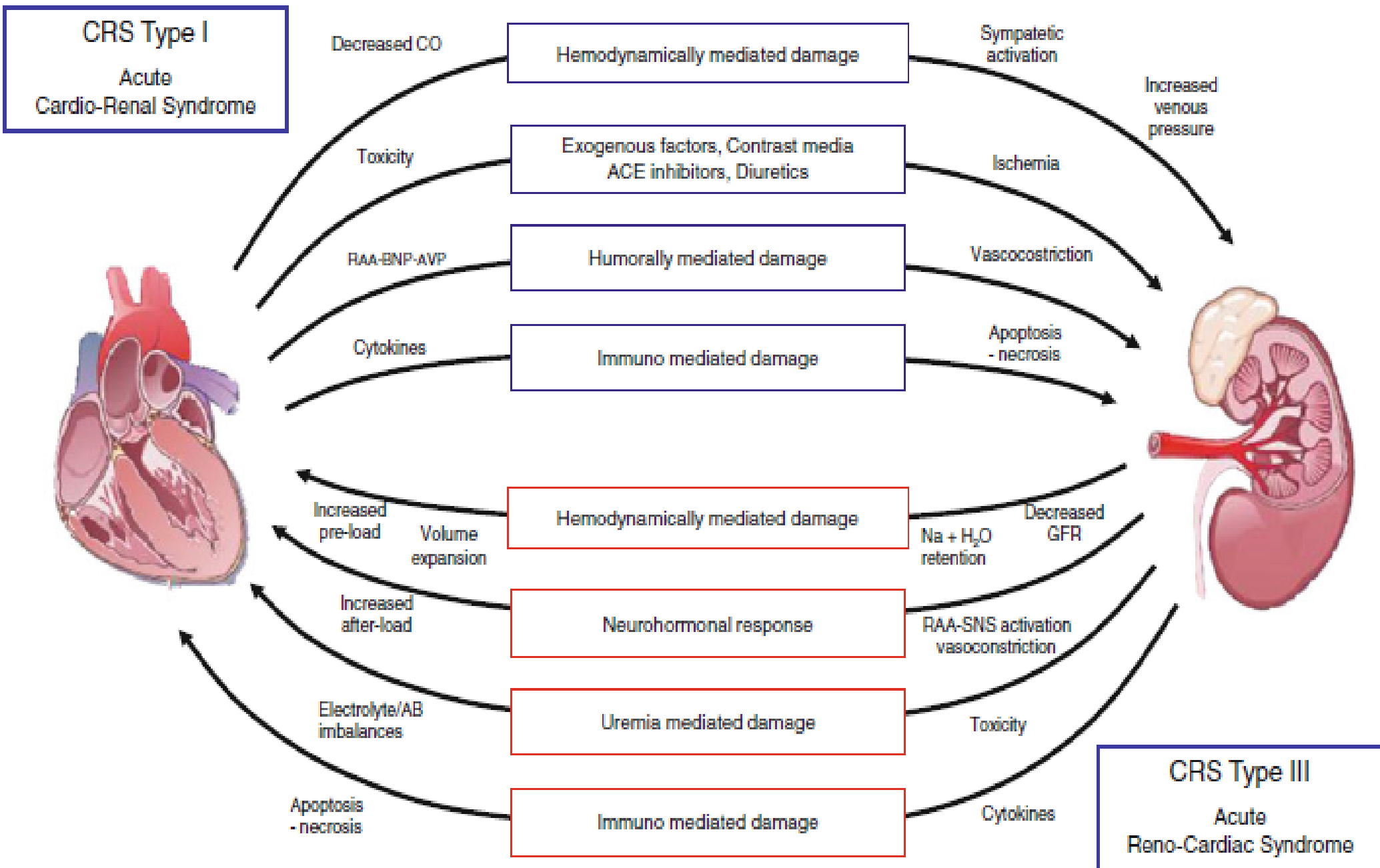

Fig. 1 Diagram illustrating and summarizing the major pathophysiological interactions between heart and kidney in types 1 and 3 cardio-renal syndromes (acute interactions)

# Acute Reno-Cardiac Syndrome

- **Type 3:** plus rare que 1,
- Surcharge HS, acidose, Hyperkaliémie, urémie : préjudiciables pour le cœur.
- Attention à l'instabilité cardiaque si **RRT**, bioincompatibilité du circuit, cathéter et risque infectieux.

**Table 18. Urinary indices**

**AKI**

Indices	Prerenal	Renal
Urine sediment	Hyaline casts	Abnormal
Specific gravity	>1.020	~1.010
Urine osmolality (mOsm per kg H <sub>2</sub> O)	>500	<350
U <sub>Na</sub> (mmol/L)	<20	>40
Fractional excretion		
Sodium (%)	<1	>2
Urea (%)	<35	>35
Uric acid (%)	<7	>15
Lithium (%)	<7	>20
Low molecular weight proteins	Low	High
Brush border enzymes	Low	High

# Fluid accumulation, survival and recovery of kidney function in critically ill patients with acute kidney injury

Josée Bouchard<sup>1</sup>, Sharon B. Soroko<sup>1</sup>, Glenn M. Chertow<sup>2</sup>, Jonathan Himmelfarb<sup>3</sup>, T. Alp Ikizler<sup>4</sup>, Emil P. Paganini<sup>5</sup> and Ravindra L. Mehta<sup>1</sup>, Program to Improve Care in Acute Renal Disease (PICARD) Study Group

*J Bouchard et al.: Fluid accumulation in acute kidney injury*

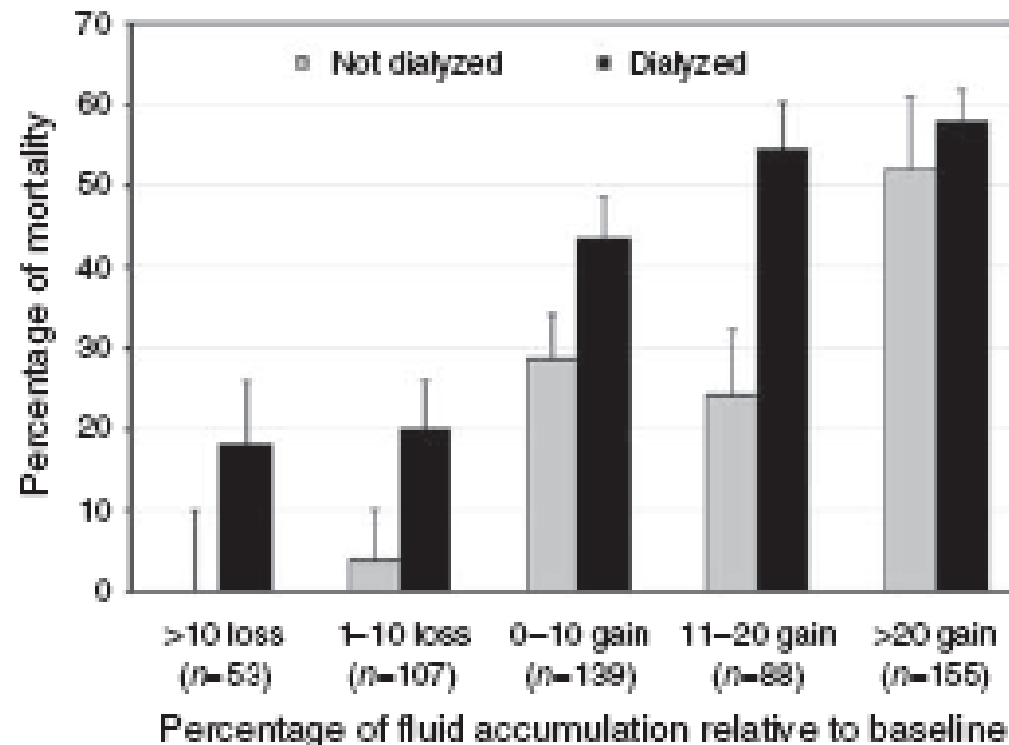

**Figure 2 | Mortality rate by final fluid accumulation relative to baseline weight and stratified by dialysis status.**

# Syndromes CR et RC chroniques

## CHRONIC HEART-KIDNEY INTERACTIONS

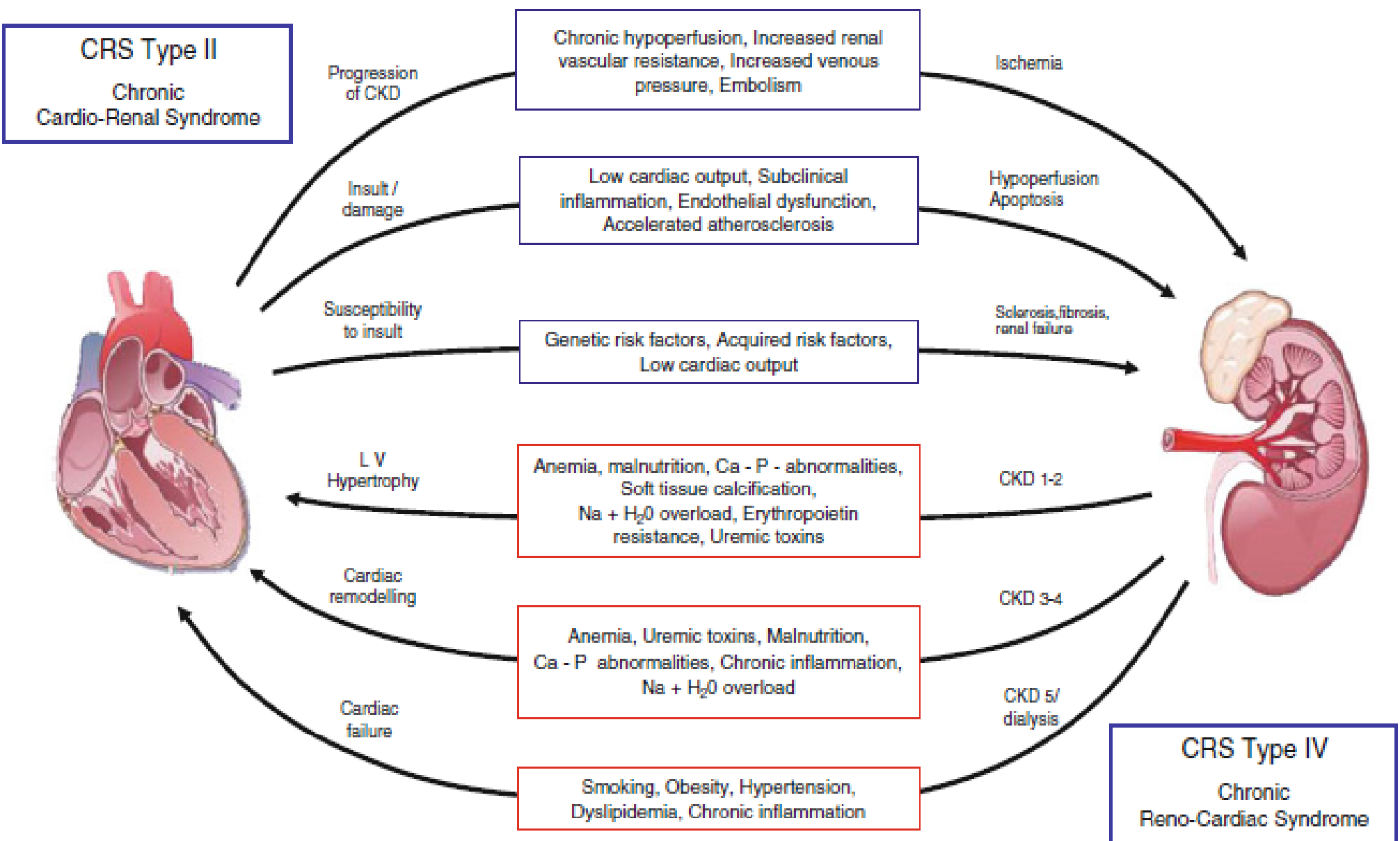
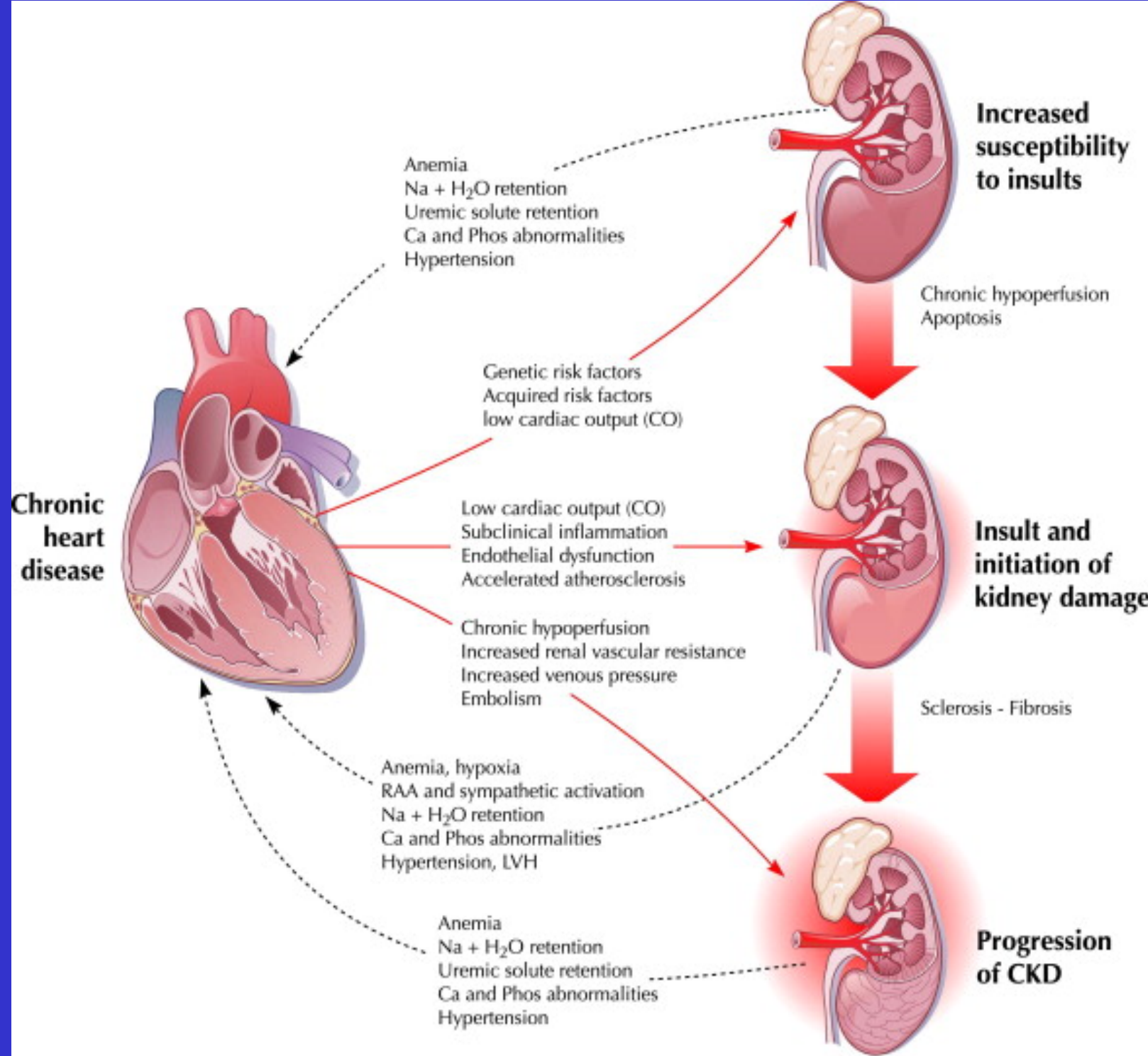

Fig. 4 Diagram illustrating and summarizing major pathophysiological interactions between heart and kidney in types 2 and 4 cardio-renal syndromes (chronic interactions)



# CRS Type 2



## Principaux traitements dans le syndrome CR de type 2.

1. Education thérapeutique (régime désodé, surveillance du poids ++)
2. Blocage simple du système RA (IEC ou ARA2) en évitant les hypotensions
- 3 Diurétique de l'anse en évitant les hypovolémies
4. Bêtabloquant liposoluble à dose permettant d'éviter hypotensions et bradycardies
5. Spironolactone si fonction rénale et kaliémie normales, (max 25 mg/j )
6. Resynchronisation si QRS long (>120 msec)
7. Correction d'une éventuelle anémie par fer intraveineux plutôt que par ASE

# Double blocage SRAA?

- **Pas d'avantage** dans CHD (Optimaal, Valliant) ou haut risque CV (Ontarget)
- **Léger avantage** dans la décompensation cardiaque systolique (ValHeft ou Charm)
- **Risque d'IRA et d'hyperkaliémie majoré**
- **Avantage** RAS blocker + spironolactone, mais..

THE EFFECT OF SPIRONOLACTONE ON MORBIDITY AND MORTALITY  
IN PATIENTS WITH SEVERE HEART FAILURE

BERTRAM PITT, M.D., FAIEZ ZANNAD, M.D., WILLEM J. REMME, M.D., ROBERT CODY, M.D., ALAIN CASTAIGNE, M.D.,  
ALFONSO PEREZ, M.D., JOLIE PALENSKY, M.S., AND JANET WITTES, PH.D.,  
FOR THE RANDOMIZED ALDACTONE EVALUATION STUDY INVESTIGATORS\*

1600 pts  
LVEF <35%  
Spironol 25mg/d vs placebo

*Conclusions* Blockade of aldosterone receptors by spironolactone, in addition to standard therapy, substantially reduces the risk of both morbidity and death among patients with severe heart failure. (N Engl J Med 1999;341:709-17.)

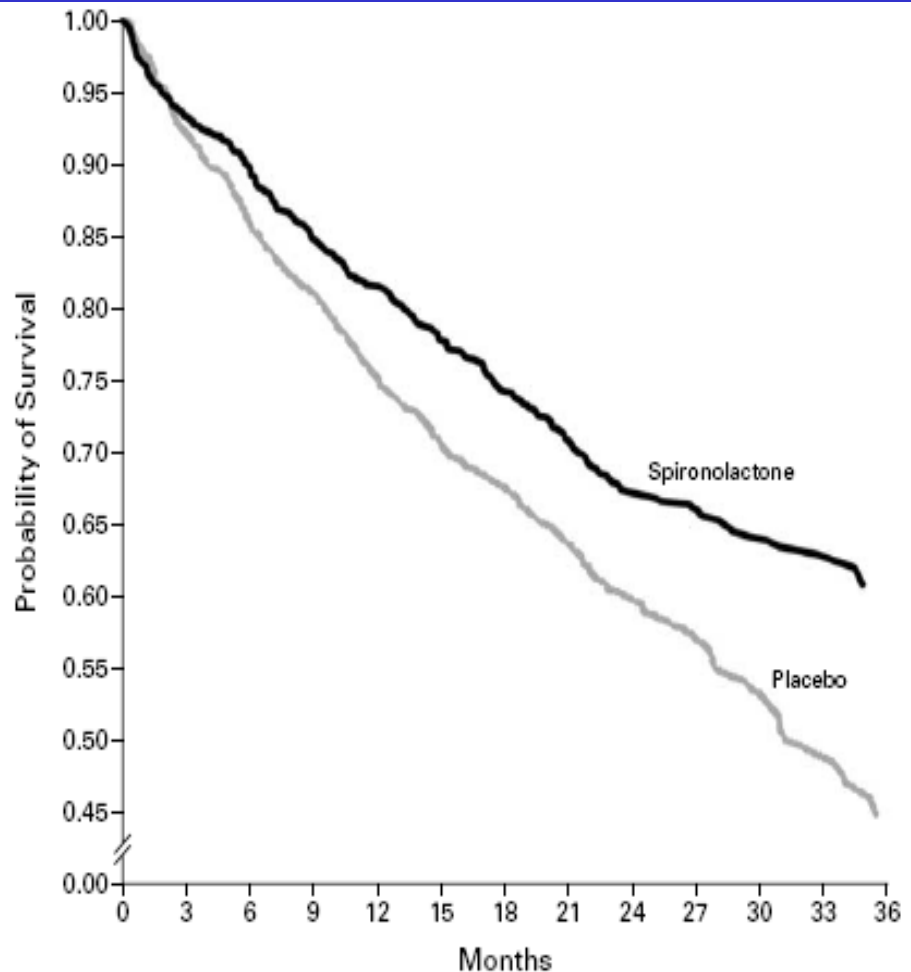

NO. AT RISK

Placebo	841	775	723	678	628	592	565	483	379	280	179	92	36
Spironolactone	822	766	739	698	669	639	608	526	419	316	193	122	43

Figure 1. Kaplan-Meier Analysis of the Probability of Survival among Patients in the Placebo Group and Patients in the Spironolactone Group.

The risk of death was 30 percent lower among patients in the spironolactone group than among patients in the placebo group ( $P < 0.001$ ).

## Rates of Hyperkalemia after Publication of the Randomized Aldactone Evaluation Study

David N. Juurlink, M.D., Ph.D., Muhammad M. Mamdani, Pharm.D., M.P.H.,  
Douglas S. Lee, M.D., Alexander Kopp, B.A., Peter C. Austin, Ph.D.,  
Andreas Laupacis, M.D., and Donald A. Redelmeier, M.D.

N ENGL J MED 351:6 WWW.NEJM.ORG AUGUST 5, 2004

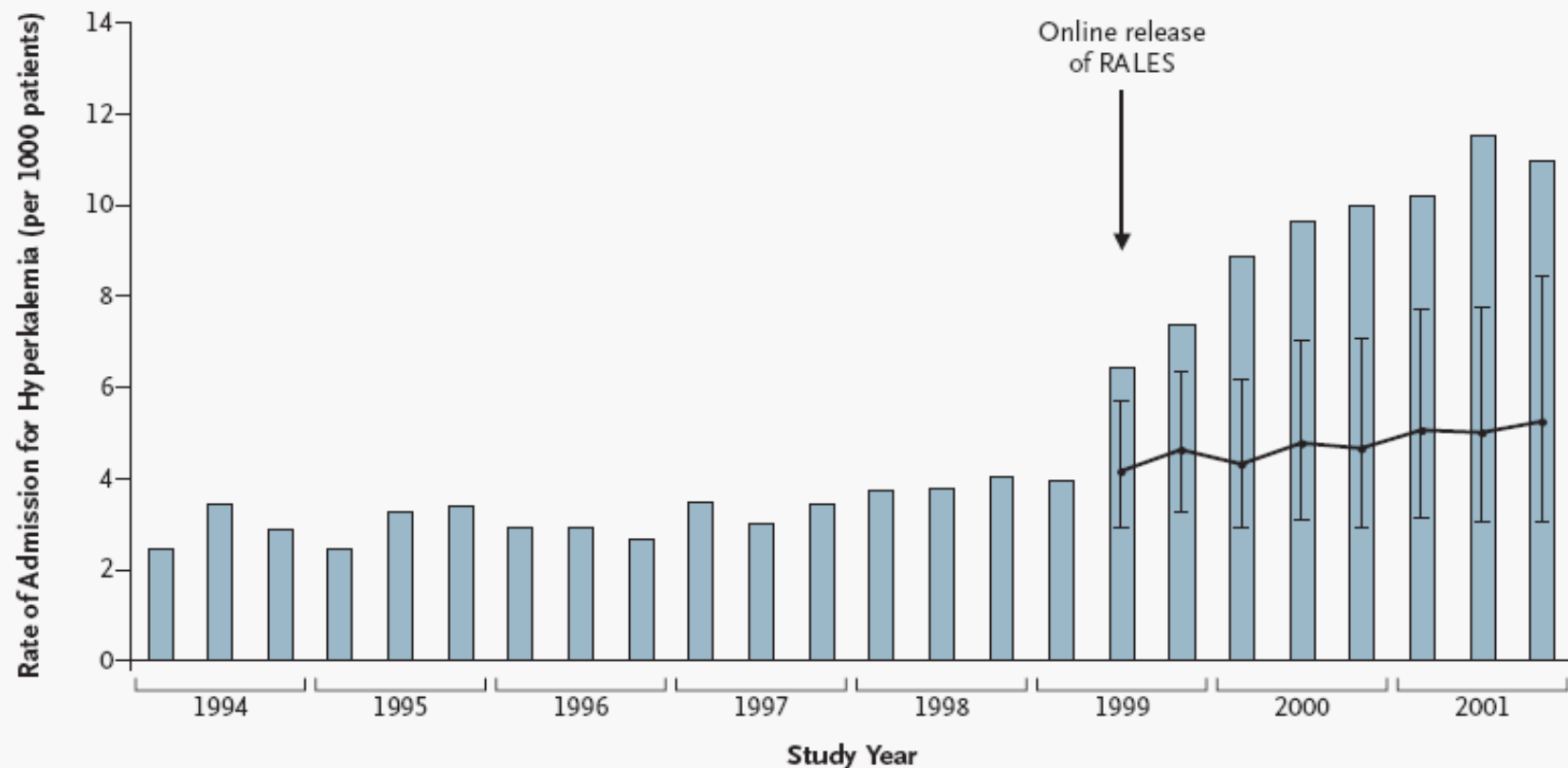

**Figure 2.** Rate of Hospital Admission for Hyperkalemia among Patients Recently Hospitalized for Heart Failure Who Were Receiving ACE Inhibitors.

Each bar shows the rate of hospital admission for hyperkalemia per 1000 patients during one four-month interval. The line beginning in the second interval of 1999 shows projected admission rates for hyperkalemia derived from interventional ARIMA models, with I bars representing the 95 percent confidence intervals.

# Hyperkaliémie ( $K > 5.5$ mmol/l)

- Mauvais prélèvement
- Apports excessifs, sels de régime
- Acidose métabolique associée
- Diurétiques d'épargne potassique, IEC et Sartan, Héparine, AINS, Ciclosporine, BBloqueurs, ...

Pas de spironolactone si Cl Créat  $< 30$  ml/min

Si HyperK  $> 5.5$  mmol/l : stop spirono, réduire RASI de  $\frac{1}{2}$

Si HyperK  $> 6$  mmol/l: stop RASI et suivre

Si HyperK  $> 7$  mmol/l: Perfusion gluconate Ca, furosémide, bicarbonate, insuline,  $\beta$ mimétiques, dialyse, Kayexalate®

**Chronic renal disease**

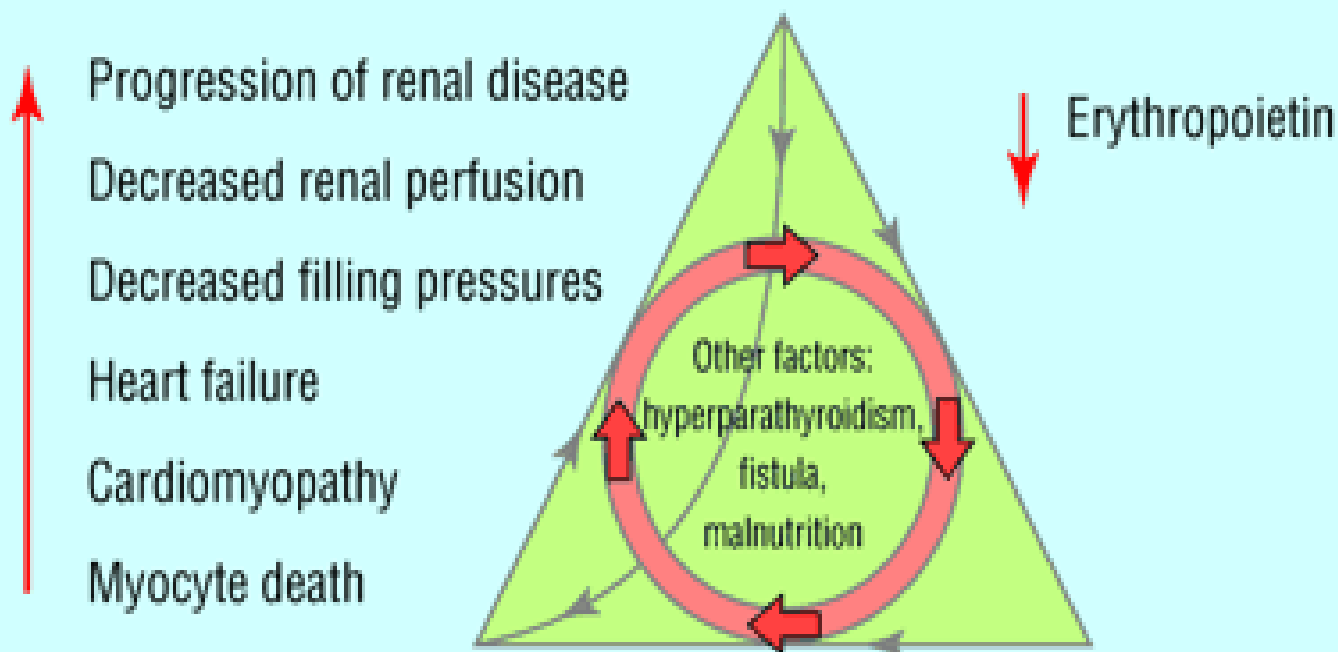

**Cardiovascular disease**

High output state

**Anaemia**

Pressure and  
volume overload

LVH and LVD

- Hémodilution
- Inhibition érythropoïèse
- État ferriprive (réel et relatif)

# Ferric Carboxymaltose in Patients with Heart Failure and Iron Deficiency



Stefan D. Anker, M.D., Ph.D., Josep Comin Colet, M.D.,  
Gerasimos Filippatos, M.D., Ronnie Willenheimer, M.D.,  
Kenneth Dickstein, M.D., Ph.D., Helmut Drexler, M.D.,\*

Thomas F. Lüscher, M.D., Boris Bart, M.D., Waldemar Banasiak, M.D., Ph.D.,  
Joanna Niegowska, M.D., Bridget-Anne Kirwan, Ph.D., Claudio Mori, M.D.,  
Barbara von Eisenhart Rothe, M.D., Stuart J. Pocock, Ph.D.,  
Philip A. Poole-Wilson, M.D.,\* and Piotr Ponikowski, M.D., Ph.D.,  
for the FAIR-HF Trial Investigators†

This article (10.1056/NEJMoa0908355)  
was published on November 17, 2009, at  
NEJM.org.

N Engl J Med 2009;361.

- Amélioration de la QOL, des symptômes et de la capacité fonctionnelle chez 459 patients avec CHF (classes NYHA II et III) recevant du fer IV si déficience en fer et Hb entre 9.5 et 13.5 g/dl



# Correction de l'anémie dans le syndrome CR type 2

## Erythropoiesis stimulating agents

Chronic CRS

May improve exercise capacity  
in patients with anaemia  
No clear impact on mortality and  
morbidity in CHF

Possible thrombogenicity and increase  
in blood pressure

## Parenteral iron

Chronic CRS

Improves exercise capacity and quality of  
life in iron deficient patients  
No clear impact on mortality and morbidity

Potential anaphylactic reaction with  
iron dextran

**Si anémie NN (Hb < 10.5 g/dL), vérifier surcharge  
liquidienne et réserves en Fer puis seulement EPO**

**Echec intérêt Aranesp avec Hb 13g/dl  
dans Déc cardiaque  
(RED-HF 2013)**

# CRS Type 4

“chronic reno-cardiac syndrome”  
(chronic kidney disease = CKD).

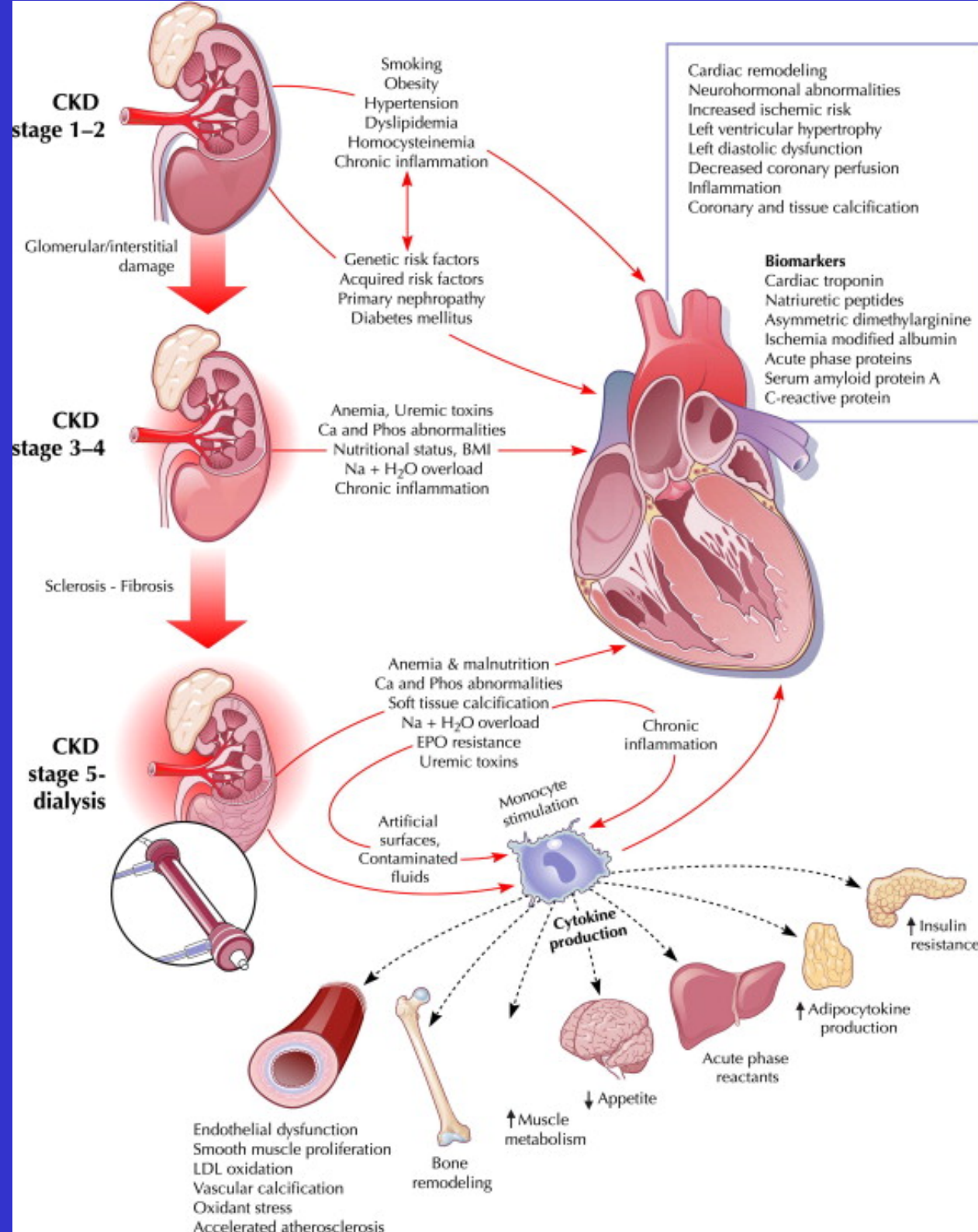

# L'IRC augmente le risque de mortalité et d'hospitalisations

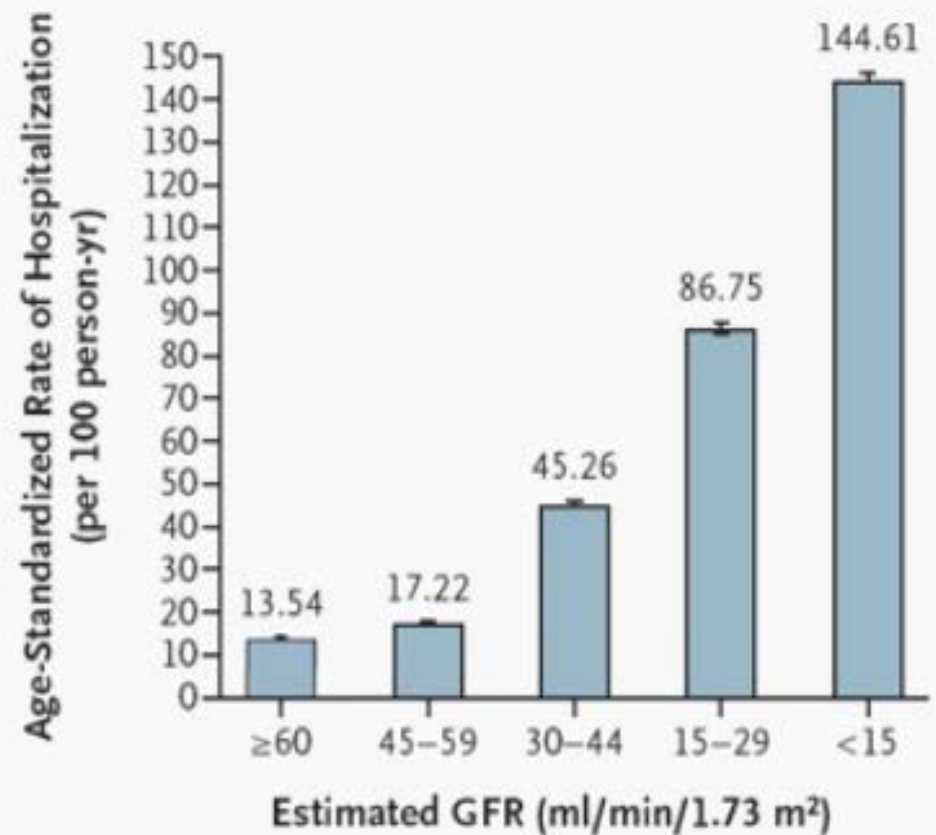
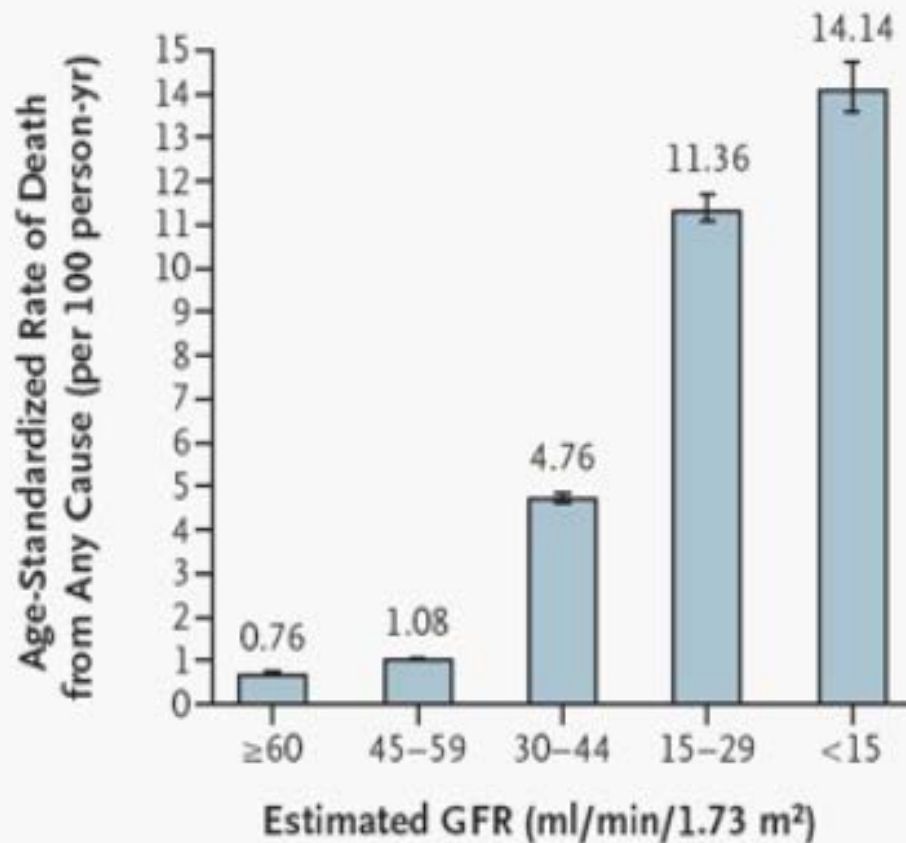

# Rates of Death at Three Years from CV Causes, Reinfarction, Congestive Heart Failure (CHF), Stroke, Resuscitation after Cardiac Arrest, and the Composite End Point, According to the Estimated GFR at Baseline (**VALLIANT**)

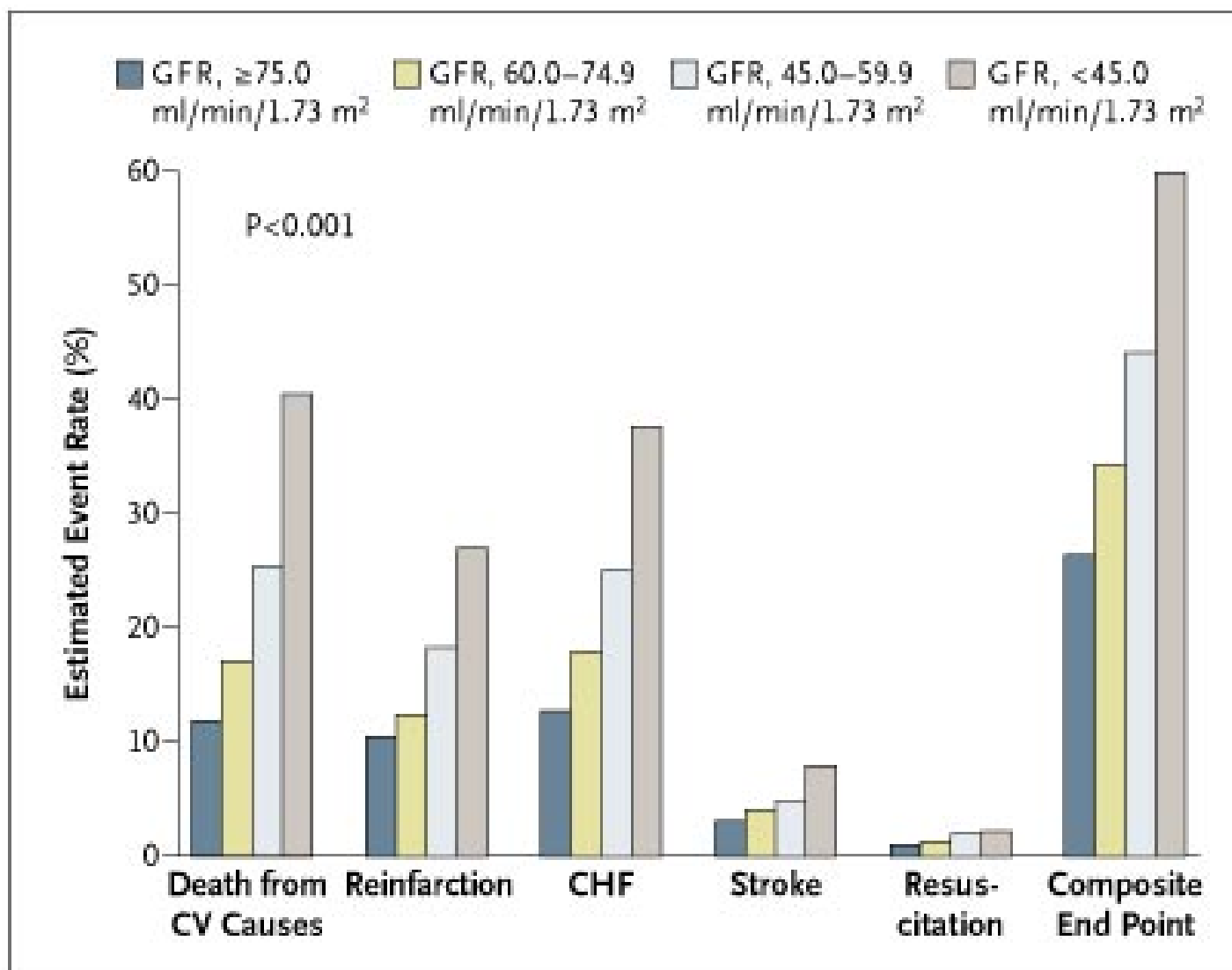

# Type 4: S. Réno-Cardiaque chronique

- 50% de la mortalité de l'IRC est CV (coronaire, décompensation cardiaque, mort subite).
- Rôle de l'HVG (HTA, anémie, FAV, PTH), calcifications vasculaires, inflammation, stress oxydatif accru et troubles ioniques.

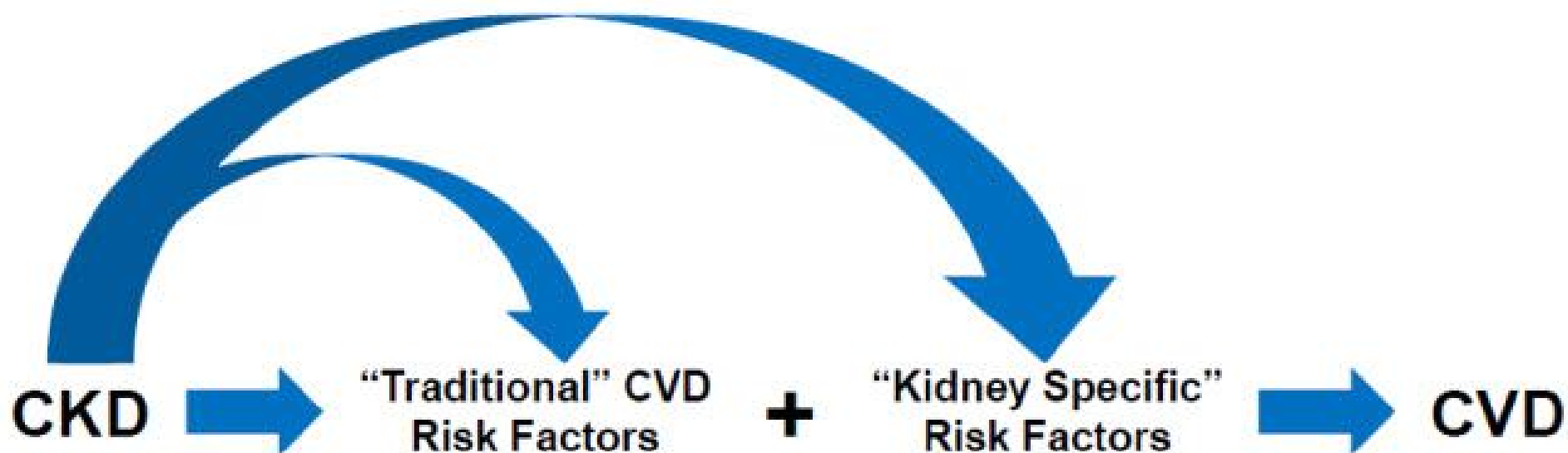

- Age
- Male gender
- Hypertension
- Dyslipidemia
- Diabetes
- Smoking
- Physical inactivity
- Family history of CVD
- LV hypertrophy

- Anemia
- Proteinuria
- Elevated Ca.P product
- Oxidative stress
- Inflammation

**Table 27 | Prevalence of CKD complications by GFR category\* derived from CKD cohorts**

Complication	GFR category (ml/min/1.73 m <sup>2</sup> )					Reference
	≥90	60-89	45-59	30-44	<30	
Anemia <sup>1</sup>	4.0%	4.7%	12.3%	22.7%	51.5%	
Hypertension <sup>2</sup>	18.3%	41.0%	71.8%	78.3%	82.1%	
25(OH) Vit D deficiency <sup>3</sup>	14.1%	9.1%	10.7%		27.2%	
Acidosis <sup>4</sup>	11.2%	8.4%	9.4%	18.1%	31.5%	
Hyperphosphatemia <sup>5</sup>	7.2%	7.4%	9.2%	9.3%	23.0%	
Hypoalbuminemia <sup>6</sup>	1.0%	1.3%	2.8%	9.0%	7.5%	
Hyperparathyroidism <sup>7</sup>	5.5%	9.4%	23.0%	44.0%	72.5%	

# Association of estimated glomerular filtration rate and albuminuria with all-cause and cardiovascular mortality in general population cohorts: a collaborative meta-analysis

Chronic Kidney Disease Prognosis Consortium\*

Lancet 2010; 375: 2073-81

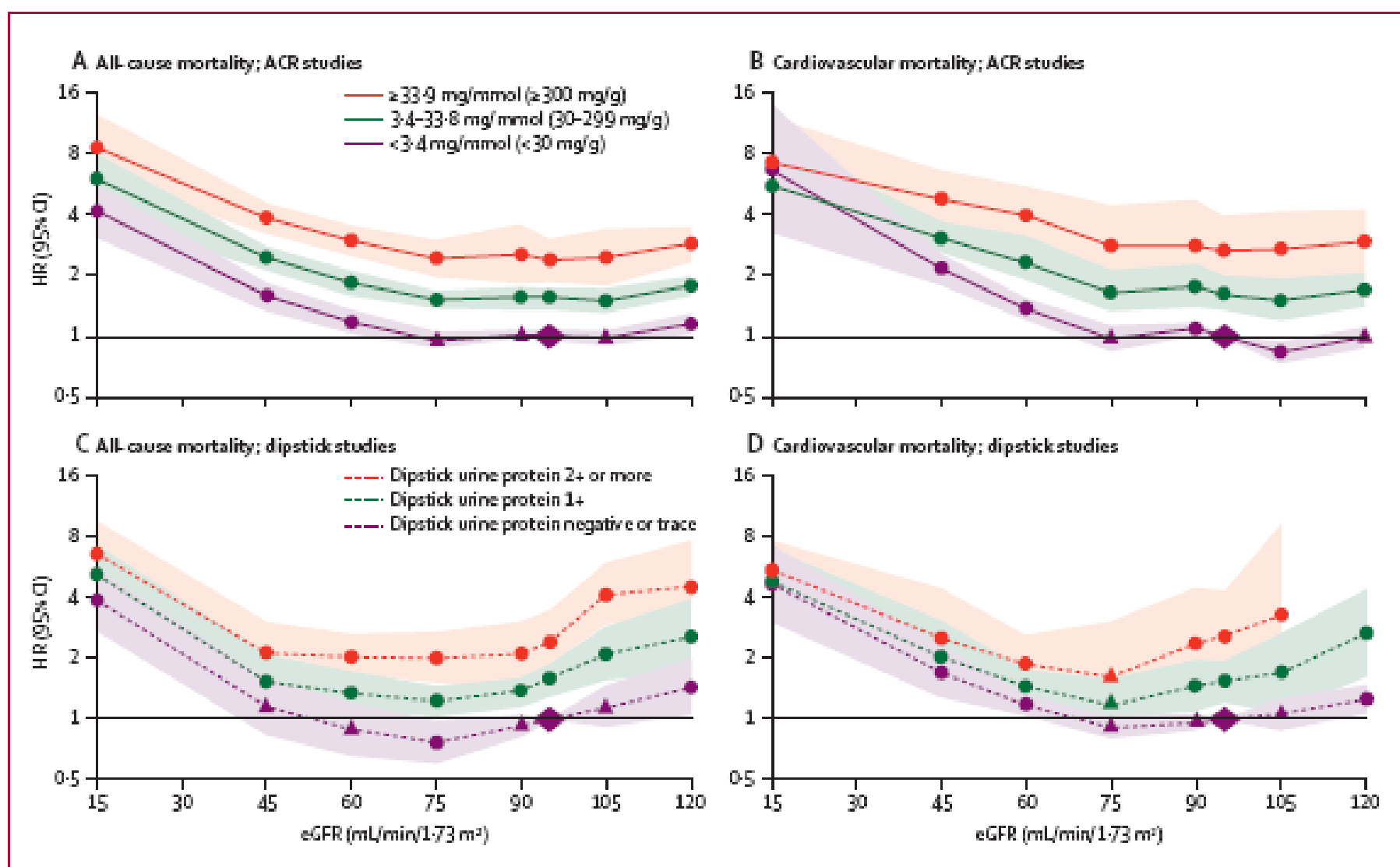

Figure 3: Hazard ratios and 95% CIs for all-cause and cardiovascular mortality according to spline estimated glomerular filtration rate (eGFR) and categorical albuminuria



# Nephro(cardio)protection

- Treatment of HTA (target 130-135 /80 mmHg)
- High dose ACEI **or** ARB + salt intake limitation!
- Low protein diet (0.8 g/Kg/j) and low Phosphate diet
- Use Statins to normalize lipids
- Low dose AAS if no high risk of bleeding.
- Correct 25OHvit D deficiency
- **If proteinuria, Target goal: proteinuria/creatininuria < 0.5 g/g**
- **Avoid too high dose of EPO (EPO resistance)**

## Attention aux médicaments à élimination rénale

- Metformine, lithium, digoxine, méthotrexate, Bbloqueur, HBPM, spironolactone

Si GFR connue  $< 50$  ml/min et  
développement de fièvre et/ou diarrhée  
et/ou vomissements:

STOP IEC, Sartan, Diurétique et contrôle  
biologique et clinique (IRA)

# CONCLUSIONS

- IR et problème cardiaque: **HAUT RISQUE CV**
- **Bonne estimation de la GFR (risque, médicament)**
- Analyse d'urine pour cause IR (fonctionnelle si CR)
- **Prise en charge sous haute surveillance (PCI,..)**
- **Correction de TOUS les FR** et de la volémie (régime pauvre en sel, choix du diurétique et de la dose, ultrafiltration ?)
- Intérêt commun pour bloqueurs système RAS
- Correction totale de la dyslipidémie, partielle de l'anémie et mise sous antiagrégant (?)
- Corriger la carence en vitamine D native
- **Collaboration cardio-néphro utile et précoce!!!**