

## Single-step reactive extrusion of PLLA in a corotating twin-screw extruder promoted by 2-ethylhexanoic acid tin(II) salt and triphenylphosphine

S. Jacobsen<sup>a</sup>, H. G. Fritz<sup>a</sup>, Ph. Degée<sup>b</sup>, Ph. Dubois<sup>b</sup> and R. Jérôme<sup>b</sup>

<sup>a</sup> Institut für Kunststofftechnologie (IKT), Universität Stuttgart, Böblinger Strasse 70, 70199 Stuttgart, Germany

<sup>b</sup> Center for Education and Research on Macromolecules (CERM), University of Liège, Sart-Tilman B6a, B-4000 Liège, Belgium

### Abstract

The ring opening polymerisation of **L**, **L**-lactide using an equimolar complex of 2-ethylhexanoic acid tin(II) salt Sn(Oct)<sub>2</sub> and triphenylphosphine P(<sub>3</sub>)<sub>3</sub> as catalyst shows for the first time a reactivity providing a polymerisation propagation rate fast enough to imagine a continuous single-step reactive extrusion process for bulk polymerisation. The ring opening polymerisation has been realised on a corotating closely intermeshing twin-screw extruder, using a specially designed screw concept to provide sufficient energy input and mixing for further enhancement of the propagation rate, without detrimentally enhancing depolymerisation or transesterification reactions. Using one chosen screw and processing concept on a twin-screw extruder with 25 mm diameter and a *L/D*-ratio of 48, the influence of different processing parameters on the resulting molecular parameters of the Polylactide (PLA) has been determined. Furthermore, the mechanical property profile of the generated PLA-polymers is discussed and related to the molecular parameters.

**Keywords:** Polylactide; Reactive extrusion; Ring opening polymerisation

### 1. Introduction

Worldwide, the problems associated with the production of large amounts of waste are recognised as one of the most serious one has to face in the following centuries. For example, the average American family produces more than 3000 kg of waste each year, which have to be disposed. In the case of plastic waste the preferred solution, up to now, is recycling. Nevertheless, degradable materials can play an important role to reduce these waste disposal problems.

Poly(lactide) (PLA), a hydrolysable aliphatic polyester, known and used since decades, mainly for medical applications [1-4], is one of the polymers widely accepted to play a major roles as a future packaging material [5-6]. This is mainly due to the good mechanical properties of PLA, being comparable to today's standard packaging polymers such as polystyrene, but also due to the fact that PLA is produced from lactic acid, which in turn can be prepared by fermentation from almost any renewable resource such as starch, molasses, whey and sugar. After use, PLA polymers can be recycled, incinerated or landfilled, though it is mainly intended for disposal by composting and in-soil degradation. Thus PLA provides a closed natural cycle, being produced from plants and crops, polymerised and processed into a packaging product and degraded after use into soil and humus, which is the basic necessity for growth of new plants and crops.

For further applications, the property profile and price of PLA can be changed by combining PLA with other biocompatible or bioacceptable polymers, fillers or reinforcements [7-8]. Alternatively, PLA can be modified by adding plasticisers to obtain more flexible materials [9-10].

PLA can be prepared in two major ways, either by a polycondensation reaction starting from lactic acid itself or by a ring opening polymerisation starting from the cyclic dimer of lactic acid, the so-

called lactide. The polycondensation pathway encounters problems in reaching high molecular weight polymers and in low molecular weight compounds or monomers remaining within the produced polymer. The ring opening pathway, in turn, offers high molecular weight polymers with nearly no remaining monomer, but includes the extra step in producing lactide from lactic acid, with all the problems associated, such as separation and purification steps.

In order to make production of PLA economically viable, the use of a continuous single-stage process is highly desirable. Therefore a reactive extrusion process is a very attractive approach, provided the bulk polymerisation of lactide can be promoted by a very efficient catalyst which meets both kinetic and PLA thermal stability requirements. In contrast to recently published polymerisation in a mini-extruder using  $\text{Sn}(\text{Oct})_2$  as catalyst [11], we reported on the favourable kinetic effect of triphenylphosphine  $\text{P}(\Phi)_3$  in an equimolar complex with  $\text{Sn}(\text{Oct})_2$ , as it enhances the polymerisation rate and delays the occurrence of undesirable back-biting reactions at least for a monomer-catalyst molar ratio of 5000 [12-13].

Within this paper an innovative ring opening polymerisation process using reactive extrusion technology and the said equimolar catalyst combination is presented. A processing and screw concept is developed to polymerise  $\text{L,L}$ -lactide into PLA using a closely intermeshing corotating twin-screw extruder. The main processing parameters such as screw speed  $n$ , throughput rate  $\dot{m}$  and die resistance, resulting in a change of extruder head pressure  $p$  are changed subsequently and their effect on the molecular parameters number average molecular weight  $M_n$ , molecular weight distribution MWD and conversion rate  $c$  is determined. The resulting PLA-polymers are analysed by means of their physico-mechanical property profile and the necessity to reach reaction equilibrium within the extrusion system is shown by comparing mechanical properties with the reached conversion rate.

For the first time an effective single-stage reactive extrusion process for the ring opening polymerisation of  $\text{L,L}$ -lactide is shown, thus providing an economically viable system for PLA production. The question is raised, if the possibility exists to transfer this technology to other polymer systems polymerised in a similar way.

## 2. Experimental studies

### 2.1. Materials

$\text{L,L}$ -lactide was purchased from Boehringer Ingelheim and used as received, having a water content <200 ppm and a remaining free acidity <1 mequ/kg. Additional  $\text{L,L}$ -lactide was provided by 2B, Brussels, having a water content of <40 ppm and containing 0.2% remaining Toluene. The remaining free acidity was determined to be 6.5 mequ/kg.

2-Ethylhexanoic acid tin(II) salt  $\text{Sn}(\text{Oct})_2$  was purchased from Th. Goldschmidt and used without purification. Triphenylphosphine  $\text{P}(\Phi)_3$  was purchased from Janssen and dried by three azeotropic distillations of toluene. A 0.15 M solution of the equimolar  $\text{Sn}(\text{Oct})_2 \text{P}(\Phi)_3$  has been prepared by dilution in freshly dried toluene. Toluene was dried by refluxing over  $\text{CaH}_2$ . ULTRANOX 626 was provided by GE Speciality Chem. and used without further purification.

### 2.2. Polymerisation

The comparing bulk batch polymerisation was carried out in previously flame dried and nitrogen purged 25 ml glass ampoules equipped with a stopcock capped with a rubber septum. These ampoules were rapidly filled with ca. 5 g of recrystallised lactide, vacuum evacuated and flushed with nitrogen several times prior to addition of the catalyst solution by a syringe with stainless steel capillary. Toluene was distilled off under reduced pressure ( $10^{-2}$  mmHg) for 30 min, and the ampoules were

finally sealed and thermostatted at a well-defined temperature. At predetermined reaction times, the ampoules were rapidly cooled down to room temperature and their content dissolved in  $\text{CHCl}_3$ .

For reactive extrusion polymerisation the lactide is used as received without further purification. An amount of 2 kg of lactide, previously mixed with 0.5 wt% of ULTRANOX 626 stabiliser, is rapidly filled into previously flame dried and nitrogen purged 51 glass bulbs, equipped with a stopcock capped with a rubber septum. The catalyst solution is added by a syringe with stainless steel capillary. Toluene was distilled off under reduced pressure for 60 min.

The prepared mixture is transferred into a constantly nitrogen purged gravimetric feeding unit, which constantly provides the test-specific-throughput to the twin-screw extruder used as polymerisation device. The lactide is fed into a closely intermeshing corotating twin-screw extruder of BERSTORFF (ZE 25), having a screw diameter of 25 mm and a  $L/D$ -ratio of 48. The machine is divided into 12 sections, which can be temperature controlled by means of electric heating devices and water cooling. The polymerisation occurs during the extrusion process at a temperature of about  $185^\circ\text{C}$ . Finally at the tip of the screw the machine is equipped with a static mixer, kindly provided by SULZER, to homogenise the material and especially to improve distribution of the stabilising system in the PLA polymer. The polymer is extruded through a strand die, cooled by a constant flow of air on a take-off unit and pelletised.

The monomer conversion was determined by FTIR and tin residues were extracted by washing successively the organic layer once with an aqueous HCl solution (0.1 M) and twice with deionised water. Part of this solution was evaporated to dryness and the solid residue (monomer+polymer) analysed by size exclusion chromatography (SEC). The second part was precipitated in cold methanol and the polymer was filtered off and dried under vacuum to a constant weight.

### 2.3. Measurements

**L**-LA conversion was calculated from the FTIR spectrum of the cast film on NaCl. A calibration plot of PL-LA to **L**-LA molar ratio versus  $A_{1383}$  to  $A_{935}$  ratio was established, where  $A_{1383}$  and  $A_{935}$  are the absorptions of the bands at  $1383$  and  $935\text{ cm}^{-1}$ , respectively. The absorption band at  $1383\text{ cm}^{-1}$  corresponds to a vibration mode shared by the polymer and the monomer while the absorption band at  $935\text{ cm}^{-1}$  is characteristic of the monomer. Practically, monomer conversion ( $c$ ) was calculated on the following equation:

$$c = 100 / ([\text{L-LA}] / [\text{PL-LA}] + 1)$$

where

$$\begin{aligned} [\text{PL-LA}] / [\text{L-LA}] = & \\ & -12.27 + 31.56(A_{1383}/A_{935}) - 26.76(A_{1383}/A_{935})^2 + \\ & 10.43(A_{1383}/A_{935})^3 - 1.81(A_{1383}/A_{935})^4 + 0.12(A_{1383}/A_{935})^5. \end{aligned}$$

Occasionally conversion was also calculated by  $^1\text{H}$  NMR from the relative intensity of the methine group of the monomer and the polymer ( $\delta\text{CH}_{\text{PL-LA}} = 5.16\text{ ppm}$ ,  $\delta\text{CH}_{\text{L-LA}} = 5.02\text{ ppm}$ ). Here  $^1\text{H}$  and  $^{13}\text{C}$  NMR spectra were recorded in  $\text{CDCl}_3$  with a Bruker AM400 apparatus at  $25^\circ\text{C}$ . Solution concentrations was 5 wt/v%. Quantitative analysis of the polylactide microstructure by  $^{13}\text{C}$  NMR required to use the 'INVGATE' sequence with a pulse width of  $30^\circ$ , an acquisition time of 0.7 s and a delay of 3 s between pulses.

Size exclusion chromatography (SEC) was carried out in  $\text{CHCl}_3$  at  $35^\circ\text{C}$  using a WATERS 610 liquid chromatograph equipped with a WATERS 410 refractometer index detector and two STYRAGEL

columns (HR1, HR5E). Molecular weight and molecular weight distribution of polylactides were calculated in reference to a polystyrene calibration and corrected to an absolute basis using an universal calibration curve ( $K_{PS}=1.67 \times 10^{-4}$ ,  $a_{PS}=0.692$ ,  $K_{PLA}=1.05 \times 10^{-3}$ ,  $a_{PLA}=0.563$  in the  $[\eta]=K \times M^a$  Mark–Houwink relationship).

DSC measurements were carried out using a NETZSCH DSC 200 in a temperature range between  $-30^\circ\text{C}$  and  $200^\circ\text{C}$  with heating rates of 5, 10 and 15 K/min, melt temperatures  $T_M$ , cold crystallisation temperatures  $T_{CC}$  and glass transition points  $T_G$  were determined in the second heating cycle. Thermal equilibration time at  $-30$ – $200^\circ\text{C}$ , before starting the next step, was set to 30 s. The cooling, in between subsequent heating cycles, was done as fast as possible. The measurements were conducted in closed aluminium pans using indium, zinc, tin and mercury calibration.

All polymer samples for mechanical tests have been injection moulded. The test pieces were conditioned for 16 h at  $23^\circ\text{C}$  and 50% relative humidity, until equilibrium was reached.

The mechanical properties were tested on a ZWICK Universalprüfmaschine 1455 using the German standard specification DIN 53455 [14]. For the determination of the elasticity modulus in tension  $E_T$ , a test speed of 1 mm/min was used up to 0.5% of elongation. Above this level the test speed was increased to 5 mm/min.

### 3. Results and discussion

#### 3.1. Comparison of bulk batch and reactive extrusion polymerisation

In a first series of experiments a typical bulk polymerisation conducted under controlled conditions in glass ampoules is compared with a reactive extrusion polymerisation carried out in a corotating twin-screw extruder. In the glass ampoule the polymerisation reaction is conducted at  $180^\circ\text{C}$  in a thermostated oven. The polymerisation reaction in reactive extrusion polymerisation is done in a closely intermeshing corotating twin-screw extruder with the processing and screw concept shown in Fig. 1. The previously prepared monomer–catalyst–stabiliser mixture is transferred into a gravimetric feeding system. This feeding system is constantly purged with dried nitrogen and provides the entrance section of the extruder, which is also constantly flushed with dried nitrogen to avoid unnecessary contact of the lactide with the moist air of the surroundings, with a constant throughput-rate of 0.7 kg/h. The used twin-screw extruder has a screw diameter of 25 mm and an  $L/D$ -ratio of 48, being one of the longer extruders, traditionally used in reactive processing. The extruder contains a modular screw and consists of several barrel parts. The screws have a rotation speed of 100 rpm. The first two barrel sections are not heated, so that the solid dimer is pushed relatively fast into the extruder. This is done using screw elements with a large helix angle. Within the third barrel section, combined with screw elements with smaller helix angles an increased temperature is used to melt the dimer and to disperse the catalyst and stabilising agent within the low viscous material. Within these first three-barrel sections, no significant polymerisation occurs, as the temperature is not high enough for a fast polymerisation. Starting with the fourth barrel section the whole twin-screw extruder until the screw tips is heated to a temperature of  $180^\circ\text{C}$ . The material inside the extruder will not have this temperature, but will have a temperature spectrum, which is in the range to deliver acceptable polymerisation conditions. Within the following screw part the oligomerisation or prepolymerisation occurs. In that purpose, three combinations of shearing and kneading elements are included. Each of these combinations includes a large kneading element, which enhances the thermal polymerisation conditions by energy dissipation, followed by elements working similar to counterrotating scissor blades. These elements will cut the material flow in ever-new single flows, creating new neighbourhoods within the melt. These shearing and mixing combinations are blocked against the flow direction. For further the advancement of the polymerisation a more powerful restriction element is chosen. In the first combination a counter conveying kneading element, in the second combination a counter conveying standard screw element and finally a blister is chosen as flow restriction element. These blocking elements are used to increase the degree of filling and the residence time of the

material inside the mixing and kneading elements, which in turn will lead to a better mixing. With increasing conversion, the viscosity of the melt will increase, and therefore the mixing of the melt becomes more relevant for the polymerisation advancement, as the potential reactive partners become even rarer. Therefore, it was decided to choose stronger flow restriction elements with increasing conversion.

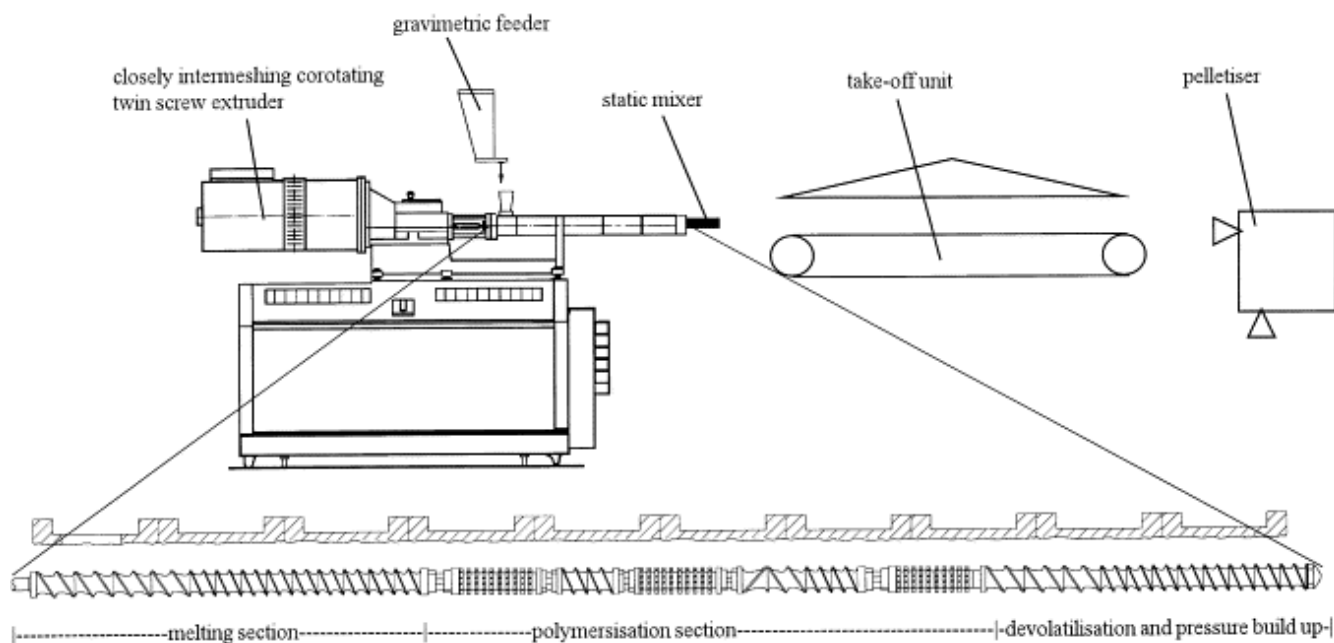

Fig. 1. Processing and screw concept used for reactive extrusion polymerisation of polylactide.

After the last pressure reduction, the melt enters a partially filled zone, using screw elements with a higher screw volume. Within this part a devolatilisation of remaining monomer or low molecular weight components from the polymer would be possible, which has proven not to be necessary in our case. Within the last two barrel-sections, screw elements with a smaller helix angle provide a pressure build-up to push the polymer through the static mixer in front of the screw tips and through the die. In this section the final polymerisation occurs under increased pressure of 30–40 bar. In the optimum case the polymerisation is continued, until the thermodynamic equilibrium is reached. It has to be noted that the state of equilibrium due to the enhanced pressure level and the thermo-mechanical energy input does not necessarily have to be the same as in similar polymerisation experiments conducted in glass ampoules under the same starting conditions.

Within the static mixer the stabiliser system ULTRANOX 626 (bis-(2,3-di-*t*-butylphenyl) pentaerythritol diphosphite used as an antioxidant) is finally dispersed within the polymer. This stabilising agent is unfortunately soluble in the dimer, but not soluble in the polymer, therefore it is enriched within the monomer and will only move into the polymer as soon as the conversion is high enough. The extruded high viscous polymer is cooled down on an air-cooled conveyer belt and pelletised afterwards.

In Table 1, poly-L-lactides produced in glass ampoule using bulk batch polymerisation technology and in single-stage continuous reactive extrusion polymerisation are compared on the basis of molecular parameters. The comparison of two polymers polymerised under such different conditions is very difficult, although the same starting conditions were used. The resulting conversions, 98.5 and 99%, show that in both cases the polymerisation reaction has been finished, though for the bulk batch polymerisation in glass ampoule the time required to reach this conversion is approximately 40 min compared with only 7–8 min in the reactive extrusion process. This difference can be explained by the fact that as soon as a high molecular weight, i.e. a high melt viscosity is reached, the speed of the

reaction is limited not by the reactivity of the chemicals, but by the diffusion of the dimers or low molecular weight compounds inside the high viscous melt to find a reactive partner. This physical movement is limited to the Brownian movement in the glass ampoule, but is supported in the twin-screw extruder by the mixing elements and by the shearing of the polymer inside the intermeshing zone.

*Table 1. Comparison of two types of poly-L-lactide polymerised in glass ampoule bulk batch polymerisation technology and using a single stage reactive extrusion polymerisation process, both catalysed with an equimolar Sn(Oct)<sub>2</sub>-P(OPh)<sub>3</sub> complex with an initial monomer to tin molar ratio of 5000 at 180°C*

Entry		$M_n \times 10^{-3}$ <sup>a</sup>	$M_w/M_n$ <sup>a</sup>	Conversion (%) <sup>b</sup>	Time (min) for conversion	
1	Glass ampoule	246.0	1.9	98.5	40	min
2	Reactive extrusion	91.1	1.8	99.0	-7	min <sup>c</sup>

<sup>a</sup>Number average molecular weight and molecular weight distribution, as determined by SEC in CHCl<sub>3</sub> eluent at 35°C relative to a polystyrene calibration.

<sup>b</sup>Monomer conversion as determined by FTIR spectroscopy.

<sup>c</sup>Estimated from the maximum residence time inside the twin-screw extruder.

The low MWD-values smaller than 2 in both cases show that intermolecular transesterification reactions have been very limited, which is due to the use of triphenylphosphine as a cocatalyst, as well as due to the use of ULTRANOX 626 as stabilising agent.

The difference in molecular weight can be explained by the fact that the lactide for the polymerisation in the glass ampoule has been recrystallised, while it has been used as received for the reactive extrusion polymerisation, and by the fact that contact of the lactide with humid air cannot be totally avoided during the transfer of the lactide from the gravimetric feeder to the twin-screw extruder.

### 3.2. Influence of process parameters on the resulting polymer

All processing parameters and the molecular parameters of the resulting polymers are gathered for easier comparison in Table 2.

*Table 2. Influence of different processing parameters during reactive extrusion polymerisation on the resulting molecular polymer parameters*

Entry	Screw speed (rpm)	Mass flow rate (kg/h)	Extruder head pressure (bar)	$M_n \times 10^{-3}$ <sup>a</sup>	$M_w/M_n$ <sup>a</sup>	Conversion (%) <sup>b</sup>	Origin of PLA
1	50	0.75	~ 30	77.0	1.80	99	2B
2	50	1.00	~ 30	81.0	1.70	97	2B
3	50	1.25	~ 30	66.0	2.10	94	2B
4	50	1.00	~ 35	83.0	1.70	94	Boehringer
5	100	1.00	~ 35	79.0	1.70	90	Boehringer
6	200	1.00	~ 35	81.0	1.80	87	Boehringer
7	100	1.00	~ 40	79.0	1.70	94	2B
8	100	1.00	~ 60	84.0	1.70	94	2B
9	100	1.00	~ 85	86.0	1.80	96	2B
10	100	1.00	~ 110	89.5	1.75	92	2B

<sup>a</sup>Number average molecular weight and molecular weight distribution, as determined by SEC in CHCl<sub>3</sub> eluent at 35°C relative a polystyrene calibration.

<sup>b</sup>Monomer conversion as determined by FTIR spectroscopy.

#### 3.2.1. Mass flow rate

In another set of experiments the influence of the mass flow rate through the extruder on the resulting polymer parameters (compare Table 2, entries 1–3) has been determined. Using the above specified processing and screw concept for the continuous polymerisation of poly-L-lactide, the mass flow rate has been changed from 0.75 to 1 kg/h and further to 1.25 kg/h. For these experiments a lactide supplied from Brussel Biotech has been used, all other processing parameters have been kept constant and especially the screw speed remained always 50 rpm. In Fig. 2 the results of this set of experiments are shown. The conversion will decrease from 99% at a mass flow rate of 0.75 kg/h over 97% to only 94% at the highest flow rate of 1.25 kg/h. This fact can be explained by the effective residence time of the material inside the extruder. The residence time will be reduced with increasing throughput, which

results in a polymerisation that has not reached the equilibrium state at the end of the die. A further increase in the throughput would result in a dramatic decrease of conversion, as the viscosity of the resulting material would be too low to provide a successful pressure build up at the die, which in turn would result in even lower conversion and lead to a complete break down of the reaction. The molecular weight increases by 4000 and the molecular weight distribution decreases slightly, while increasing the mass flow rate from 0.75 to 1 kg/h, which can be explained by already starting degradation reactions at the experiment with 0.75 kg/h mass flow rate, reducing the chain length again, after reaching the maximum conversion. If the throughput is further increased to 1.25 kg/h, as already described the state of equilibrium cannot be reached anymore, resulting not only in reduced conversion, but also in a dramatically reduced molecular weight and in a broader molecular weight distribution, due to the occurrence of smaller chains.

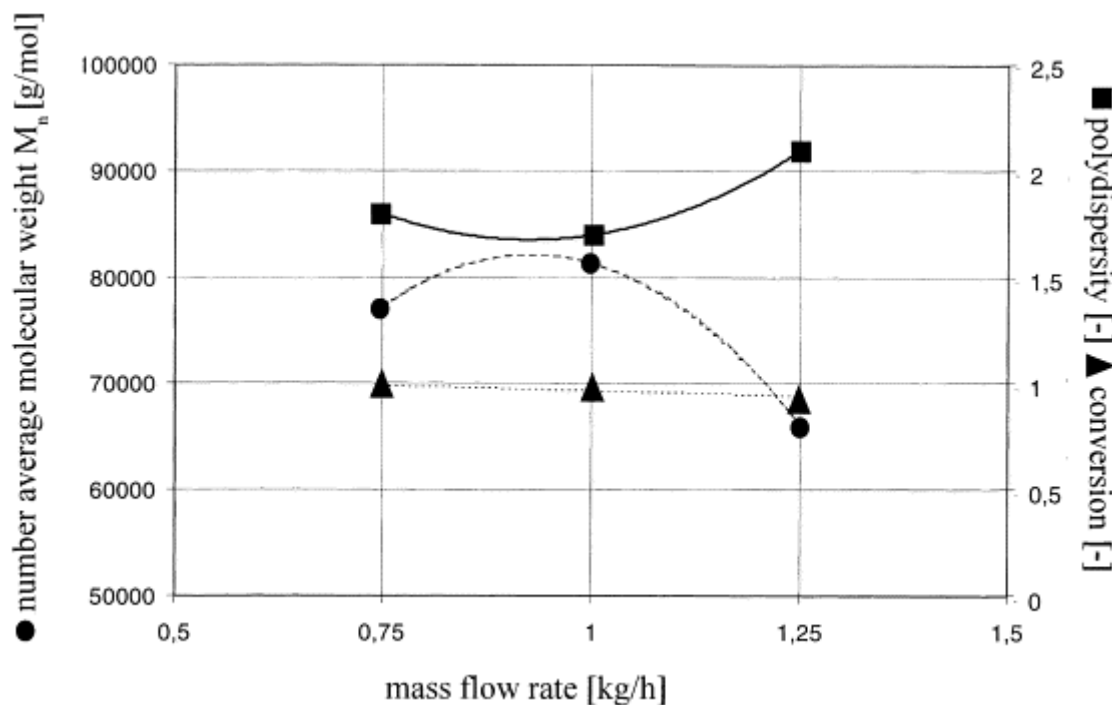

Fig. 2. Molecular parameters of poly-L-lactide received in reactive extrusion polymerisation in dependence of the mass flow rate in the extruder.

### 3.2.2. Screw speed

An additional set of experiments was used to determine the influence of the extruder screw speed on the resulting polymer parameters (compare Table 2, entries 4–6). These experiments have been carried out using a mass flow rate of 1 kg/h. The screw speed was varied between 50, 100 and 200 rpm and a L-lactide from Boehringer has been used. Raising the screw speed from 50 to 100 rpm and further up to 200 rpm reduces the degree of conversion (cf. Fig. 3), similar as it has already been shown increasing throughput. The reason for this behaviour is the same, as the remaining residence time inside the twin-screw extruder decreases with increasing screw speed, which results in a reaction not finished at the extruder die. For the effect of the screw speed on the molecular weight and the molecular weight distribution, two main influences can be described. First increased screw speed leads to reduced residence time, which in turn should reduce the molecular weight and enhance the polydispersity. Second the higher screw speed increases the degree of mixing and the shear introduction into the melt, which in turn increases the rate of reaction, favouring degradation and side reactions to enhance the polydispersity. Thus it is necessary to find a balance between these effects influencing the polymer parameters in opposite directions.

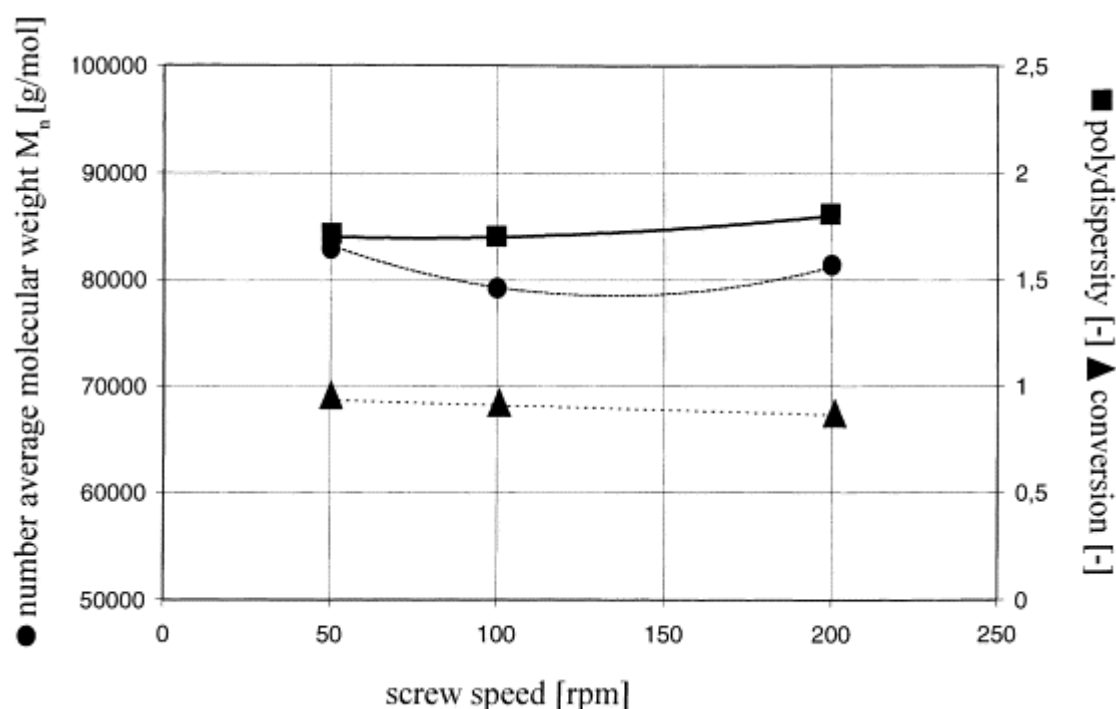

Fig. 3. Molecular parameters of poly-L-lactide received in reactive extrusion polymerisation in dependence of the screw speed of the extruder.

### 3.2.3. Die resistance—extruder head pressure

Finally in a last set of experiments, the influence of the die resistance, which results in a change of the extruder head pressure—the final pressure at which the polymerisation reaction will be finished—on the resulting polymer parameters (cf. Table 2, entries 7–10) has been determined. For these experiments, following the same principal aspects as before, lactide originating from Brussels Biotech has been used. A throughput rate of 1.0 kg/h and a screw speed of 100 rpm were chosen as additional processing parameters. The pressure in front of the die has been changed by adapting the die resistance. Different pressure levels of 40, 60, 86 and 110 bar have been realised and the results are shown in Fig. 4. The increase in the extruder head pressure influences the state of reaction equilibrium, which is shifted to the polymer side for high-pressure levels. In addition, the totally filled zone, in front of the die, is likely to be larger with an increased pressure level, which leads to an increase in residence time and increased deformation in this final step of the polymerisation reaction. All these criteria are in favour of the polymerisation reaction. Indeed, experimental data showed an increase in number average molecular weight from 80,000 g/mol to nearly 90,000 g/mol, while increasing the extruder head pressure from 40 to 110 bar. The polydispersity showed no tendency to change with pressure, while the conversion increased slightly. The value for the test at 110 bar cannot be taken as granted, as the experiment has to be stopped before reaching the steady state, due to far too high axial back pressure of the screws.



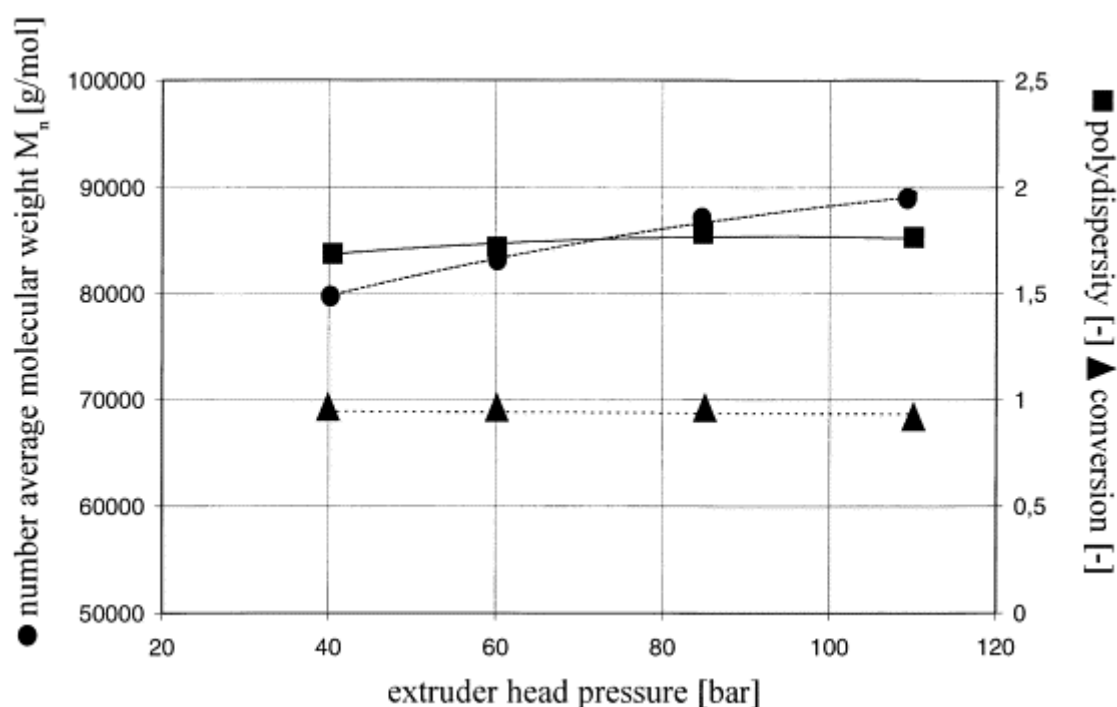

Fig. 4. Molecular parameters of poly-L-lactide received in reactive extrusion polymerisation in dependence of the die resistance/extruder head pressure.

### 3.2.4. Thermal behaviour

To determine the thermal behaviour of the resulting polylactide DSC measurements have been carried out (see Table 3). Results of a typical polylactide produced in a reactive extrusion polymerisation with a molecular weight of  $M_n=91,000$  g/mol and a polydispersity of 1.6 are shown in Fig. 5. The samples have been heated to 200°C and quenched rapidly to -30°C to prevent them from crystallisation. Following this, they were heated from -30°C to 200°C with a constant heating rate of 5, 10 or 15 K/min. Heating the totally amorphous polylactide, the first to meet is the glass transition with an onset temperature varying between 36°C for 5 K/min heating rate and 44.2°C at 15 K/min heating rate. The step in  $c_p$ -value is in between 0.57 and 0.67 J/gK. In principal the onset temperature is shifted to higher temperatures with higher heating rate.

Table 3. Thermal properties of poly-L-lactide produced in reactive extrusion polymerisation as derived from DSC-measurements, using different heating rates

Entry	Heating rate (K/min)	Glass transition		Cold crystallisation		Melting		
		Onset (°C)	$\Delta c_p$ (J/g K)	$T_{cc}$ (°C)	$\Delta H_{cc}$ (J/g)	$T_{m1}$ (°C)	$T_{m2}$ (°C)	$\Delta H_m$
1	5	36.3	0.67	87.2	32.7	144.0	163.6	34.4
2	10	40.8	0.57	98.5	33.7	153.0	167.9	34.0
3	15	44.2	0.59	103.0	32.7	157.5	166.3	32.1

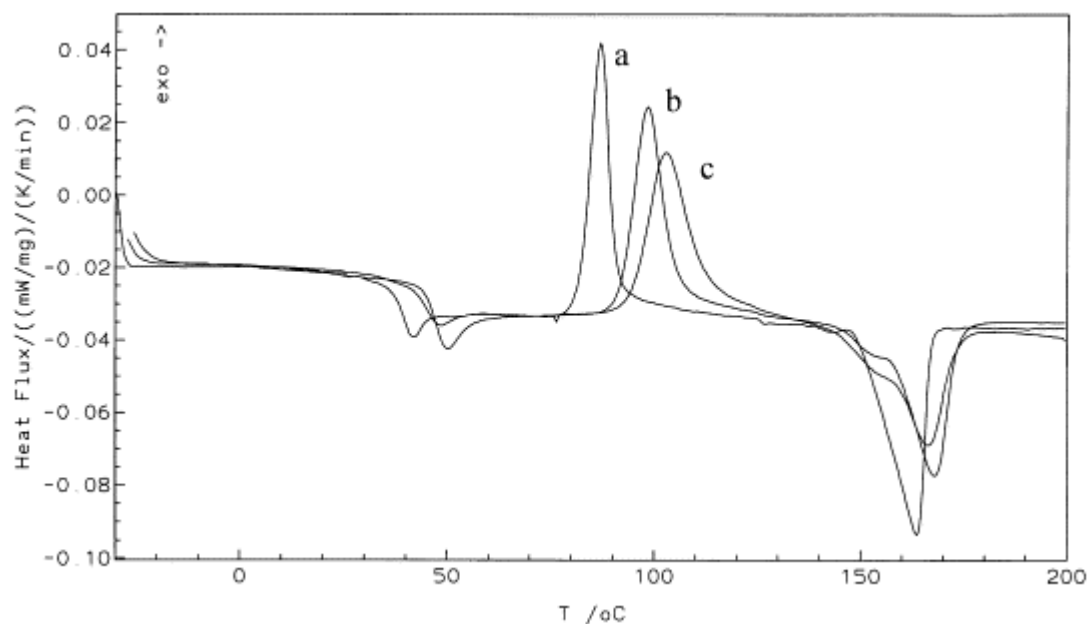

Fig. 5. DSC-measurements of poly-L-lactide produced in reactive extrusion polymerisation. First heating after quenching at different heating rates: a=5 K/min, b=10 K/min, c=15 K/min.

At temperatures between 87°C (at 5 K/min) and 103°C (at 15 K/min) a cold crystallisation process occurs. The crystals formed have an enthalpy of  $\sim 32$  J/g, nearly independent of the heating rate. The huge shift in cold crystallisation temperature is known for other polyesters such as PET.

The crystals formed melt again at higher temperature in form of a double peak, which is characteristic for polylactide, the lower peak corresponding to  $\beta$ -crystals and the upper peak corresponding to  $\alpha$ -crystals. Both melt temperatures  $T_{m1}$  and  $T_{m2}$  are shifted to higher temperatures with increasing heating rate.

Even if one accounts for the lower melting temperature, polylactide can be used in a crystallised form at temperatures up to 120°C similar to other standard polymers in packaging applications.

### 3.2.5. Mechanical behaviour

Mechanical properties were determined by means of tensile testing. It is known that the mechanical properties, especially the tensile strength of poly-L-lactide levels off to a plateau region above a certain number average molecular weight. The purpose of this development for reactive extrusion polymerisation was to receive polymers with a molecular weight far above this limit. As the differences in molecular weight distribution are small and all distributions are smaller than 2.0 there should be no effect of the distribution on the mechanical properties either. In contrast the variation of the degree of conversion may alter the material properties. It is already known that a polymer with a conversion rate below 90% is not suited for most applications, requiring mechanical strength.

Although, at conversion rates above 90%, certain amount of remaining monomer is acceptable, the monomer in these cases will work like an internal plasticiser and alter the mechanical properties. As an example, in Fig. 6 the dependency of the tensile strength as function of the degree of conversion can be seen. Within this region above 90% conversion, or less than 10% of remaining monomer, there is a linear dependency between conversion/monomer content and tensile strength.

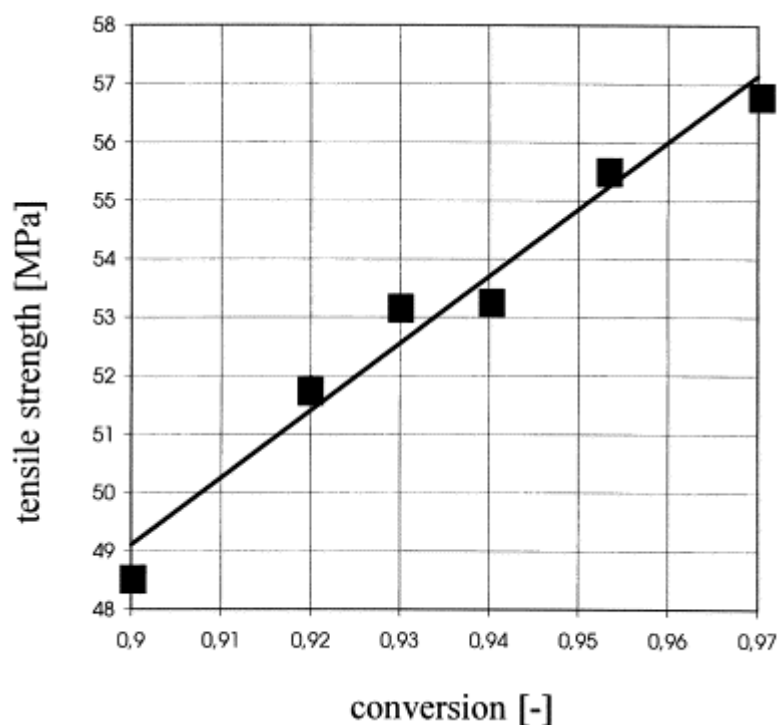

Fig. 6. Tensile strength as a function of reached degree of conversion for poly-L-lactide produced in reactive extrusion polymerisation.

#### 4. Conclusion

The extraordinary effect of triphenylphosphine on the efficiency of  $\text{Sn}(\text{Oct})_2$  as a catalyst for the ring opening polymerisation of L,L-lactide into polylactide was the starting point to use reactive extrusion technology to produce PLA. Corotating closely intermeshing twin-screw extruders have often been used for polymerisation reactions, but in any case, the reaction time was sufficiently smaller than the residence time in the extruder. In this case a sophisticated screw design has been used to ensure further enhancement of the polymerisation reaction by using mixing elements and by the introduction of shear into the melt. Thus it was possible to realise a single stage process using reactive extrusion technology to polymerise L,L-lactide and to achieve a poly-L-lactide which does not have to be treated afterwards, but can be used right away from the process for any known polymer processing technology. The resulting polymer exhibits thermal and mechanical properties which allow polylactide to be used in a wide range of nowadays polymer applications.

#### Acknowledgements

The authors are grateful for the financial support from the European Commission for the AIR-project 'Development of innovative biodegradable polylactic acid-polymers, based on agricultural raw materials for new industrial applications'.

#### References

- [1] Kricheldorf HR, Kreiser-Saunders I. *Macromol Symp* 1996;103:85- 102.
- [2] Nieuwenhuis J, Mol AC. EP 314,245; Chem Abstr 1989.
- [3] Ething B, Gogolewski S, Pennings AJ. *Polymer* 1982;23:1587.
- [4] Sinclair RG. ANTEC'87, p. 1214-9.
- [5] Sinclair RG. *JMS-Pure Appl Chem* 1996;A33(5):585-97.
- [6] Gruber PR, Kolstad ES, Iwen ML, Benson RD, Borchart RL. WO 93 15 127, 1993.
- [7] Hiljanen M, Varpomaa P, Seppälä J, Törmälä P. *Macromol Chem Phys* 1996;197:1503-23.

- [8] Jacobsen S, Fritz HG. Polym Eng Sci 1996;36(22):2799-804.
- [9] Rehberg CE, Dixon MB, Dietz TJ, Fisher CH. Ind Eng Chem 1950;July:1409-11.
- [10] Jacobsen S, Fritz HG. J Polym Sci: Part A: Polym Chem 1999;37:2413-20.
- [11] Stevels WM, Bernard A, Van de Witte P, Dijkstra PJ, Feijen J. J Appl Polym Sci 1996;62:1295.
- [12] Degee Ph, Dubois Ph, Jerome R, Jacobsen S, Fritz HG. Polym Eng Sci 1999;39(7):1303-10.
- [13] Fritz HG, Jacobsen S, Degree Ph, Dubois Ph, Jerome R. German patent application DE 196 284 72.4, 1996.
- [14] DIN 53 455, Prüfung von Kunststoffen-Zugversuch, 08.1991.